

**FOLLOWING US IN**

Facebook . Twitter . Instagram . Pinterest . Youtube . LinkedIn

mAntra

mAntra

www.mantrailuminacion.com

FUSION 2017

Polígono Industrial los Vientos - Calle Alisio, parcela nº4 - 46119, Náquera, Valencia, SPAIN  
T +34 96 160 99 50 - F +34 96 160 99 48 - mantra@mantraco.org - www.mantrailuminación.com

F U S I O N

# FUSION

---

2017

mAntra

# PHILOSOPHY

"... Siente la luz", es la frase que viste y acompaña nuestra imagen desde el nacimiento de MANTRA.

"... Siente la luz, transmite la "filosofía" que pretendemos inspirar con nuestra forma de hacer. Los elementos de las colecciones además de iluminar, aportan sencillez y belleza, sin caer en la ostentación o lo vulgar.

Lámparas y auxiliares presentan una depuración de líneas y cierta personalidad, otorgándoles un toque sutil diferenciador.

Por eso confiamos en el buen hacer... la profesional labor de nuestros diseñadores y en nuestro criterio a la hora de crear y seleccionar objetos de iluminación que aporten personalidad, carácter y que a su vez alumbren de forma eficaz y efectiva sus espacios de una manera especial.

"... Siente la luz... siente MANTRA".

*"... Feel the light" is a phrase which has decorated and accompanied our image since the founding of MANTRA.*

*"... Feel the light" transmits the "philosophy" which we aim to inspire with our way of working. The elements of the collections not only provide lighting but they also decorate with elegant simplicity and beauty without excess ostentation or gaudy style.*

*Lamps and accessories provide graceful streamlined designs with a special personality, which give them a subtle differentiating touch.*

*Consequently, we trust in the craftsmanship... the professional work standards of our designers and our criteria when creating and selecting lighting products which provide distinctive personality and character as we efficiently and effectively light up your spaces with a special style.*

"... Feel the Light... Feel MANTRA".

*« ... Sentez la lumière », est le slogan qui accompagne l'image de MANTRA depuis son origine.*

*« ... Sentez la lumière » véhicule la philosophie que nous désirons inspirer par le fruit de notre travail. Les pièces de nos collections sont bien évidemment des sources de lumière, mais elles apportent également de la légèreté et de la beauté, sans jamais être ostentatoires ou vulgaires.*

*Les lampes et les compléments présentent des lignes épurées et une personnalité propre qui leur confèrent leur caractère distinctif.*

*Grâce à notre savoir-faire, au professionnalisme de nos designers et à notre jugement, nous créons et sélectionnons des luminaires qui apportent une touche originale et singulière tout en éclairant différemment et efficacement vos espaces.*

*« ... Sentez la lumière... sentez MANTRA ».*

# BRAND



MANTRA es una joven empresa que comenzó su actividad en el sector de la iluminación a mediados del año 2000. Con creación y diseño propio, ha intentado aportar una "iluminación accesible, con diseño y calidad al alcance de todos", convirtiéndose este "lema" a partir de aquel momento en nuestro objetivo a desempeñar.

En un primer momento nuestro catálogo pretendió satisfacer el mercado español y los mercados vecinos, apostando con una amplia red de representación. Hoy podemos decir que MANTRA es conocida en gran parte del mundo al comercializar sus productos en Europa, América, Oriente Medio y Sudeste Asiático.

Confiamos en el buen hacer y la profesional labor de nuestros diseñadores y en nuestro criterio a la hora de crear y seleccionar objetos de iluminación que aporten personalidad, carácter y que a su vez iluminen de forma eficaz y efectiva sus espacios de una manera especial.

*MANTRA is a young company which started its activity in the lighting industry in mid-2000. With creation and design in Spain, we tried to make an "affordable lighting, with design and quality available to everyone", becoming this "catchword" in own objective.*

*In first time we intended satisfy our catalogue Spanish market and neighboring markets, betting with a wide network representation. Today we can say that MANTRA is known in much of the world to market their products in Europe, America, Middle East and Southeast Asia.*

*We trust in the professional work standards of our designers and our criteria when creating and selecting lighting products which provide distinctive personality and character as we efficiently and effectively light up your spaces with a special style.*

*MANTRA est une entreprise relativement jeune qui a débuté son activité dans le secteur des luminaires en l'an 2000. Elle crée et conçoit ses propres luminaires, mais a décidé de les faire fabriquer en Chine étant donné la différence évidente de coût et les avantages qu'apportent une fabrication dans ce pays... afin d'offrir des « luminaires abordables, au design et à la qualité à la portée de tous ». Dès lors, cette devise est devenue l'objectif à atteindre.*

*Dans un premier temps, notre catalogue était destiné au marché espagnol et aux marchés limitrophes, grâce à un important réseau de représentants. Néanmoins, nous pouvons aujourd'hui affirmer que MANTRA est mondialement connue puisqu'elle commercialise ses produits en Europe, aux États-Unis, au Moyen-Orient et en Asie du Sud-Est.*

*c'est pourquoi, nous confions notre savoir-faire, au professionnalisme de nos designers et à notre jugement, nous créons et sélectionnons des luminaires qui apportent une touche originale et singulière tout en éclairant différemment et efficacement vos espaces.*

# INDEX

ARGENTA	56
ARI	90
AROS	8
BOLA	116
BURBUJA	120
CENTARA	86
CORAL	140
CRYSTAL BALLS	170
CRYSTAL BRONCE	184
CRYSTAL G9	178
CRYSTAL LED	154
CRYSTAL LED MIRROR	164
CUADRAX	218
CUBE	46
DIAMANTE	70-71
DIAMANTE II	72
KAWAI	188
LADY	98
LOOP	204
MALDIVAS	63
MALE	82
MAREMAGNUM	198
NATALIA	110

NISEKO	18
O2	192
ONDAS	69
PETACA	50
READING	102
REEF A-B	64-65
REFLEX	94
SATURNO	150
SPEAKER	68
STRASS	128
SURF	34
SWISS	42
TUBE	124
VERSAILLES	22
VINTAGE	132
VIRGIN	67
VIRGIN SAND	66
WINDOWS	146
ZEN	212
ZERO 3673	62
ZERO	68
ZERO II	76
ZURICH	28

# AROS





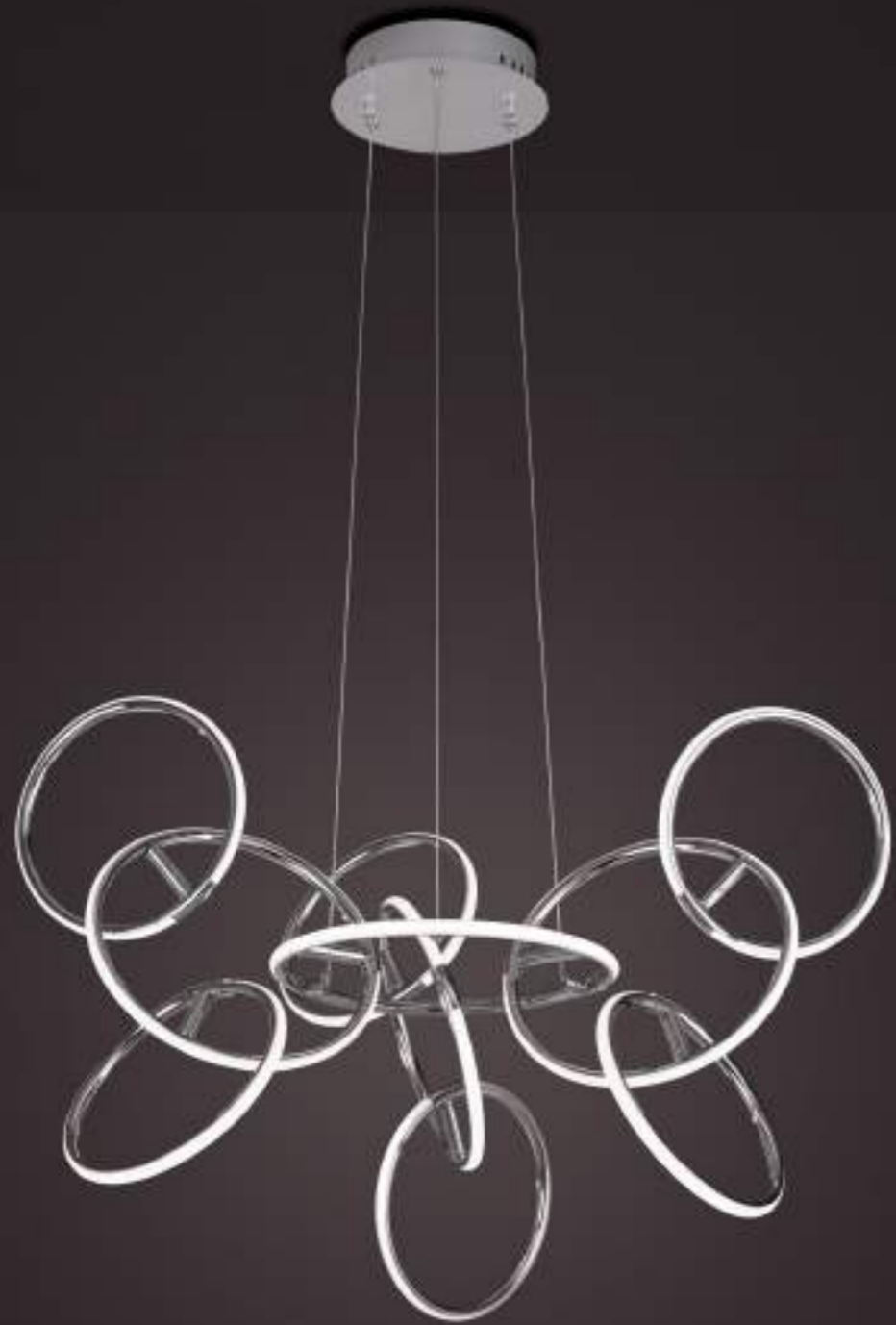





## REF.5750 DIMMABLE Colgante - Pendant Lamp



LED 102W 3000K 4420lm - 220/240V

Cromo - Chrome

Difusor Acrílico - Acrylic Diffuser

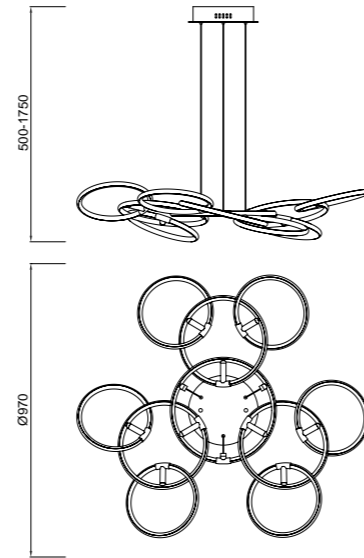

## REF.5751 DIMMABLE Colgante - Pendant Lamp



LED 81W 3000K 3500lm - 220/240V

Cromo - Chrome

Difusor Acrílico - Acrylic Diffuser

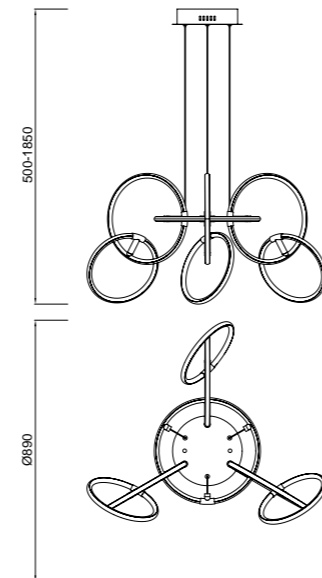

## REF.5752 DIMMABLE Colgante - Pendant Lamp



LED 59W 3000K 2600lm - 220/240V

Cromo - Chrome

Difusor Acrílico - Acrylic Diffuser

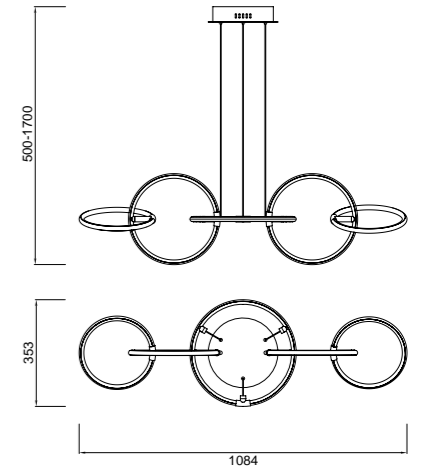

## REF.5755 DIMMABLE Semi Plafón - Semi Ceiling Lamp



LED 59W 3000K 2600lm - 220/240V

Cromo - Chrome

Difusor Acrílico - Acrylic Diffuser

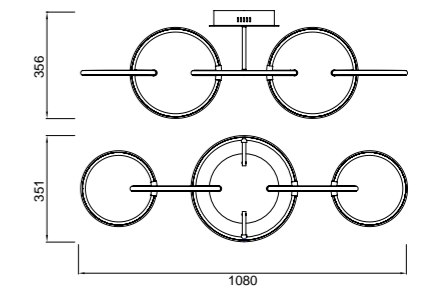

## REF.5756 DIMMABLE Plafón - Ceiling Lamp



LED 46W 3000K 2050lm - 220/240V

Cromo - Chrome

Difusor Acrílico - Acrylic Diffuser

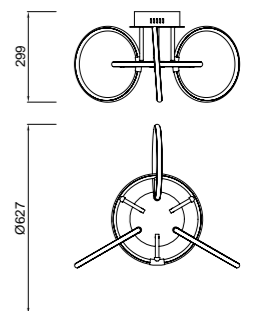

# NISEKO



# NISEKO

DATOS TÉCNICOS / TECHNICAL DATA



REF.5795

## REF.5795 DIMMABLE Colgante - Pendant Lamp



- LED 60W 3000K 4200lm - 220/240V
- Metal Blanco Mate - White Metal Matt
- Difusor Acrílico - Acrylic Diffuser

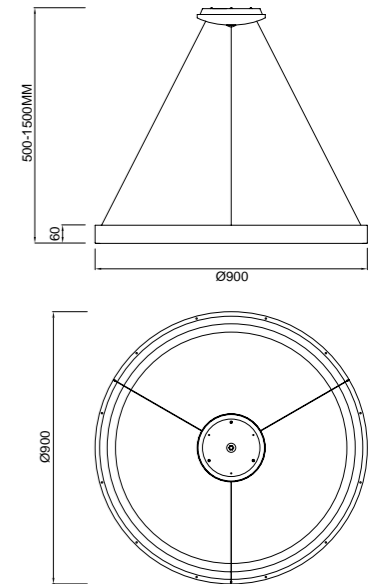

## REF.5796 DIMMABLE Colgante - Pendant Lamp



- LED 50W 3000K 3500lm - 220/240V
- Metal Blanco Mate - White Metal Matt
- Difusor Acrílico - Acrylic Diffuser

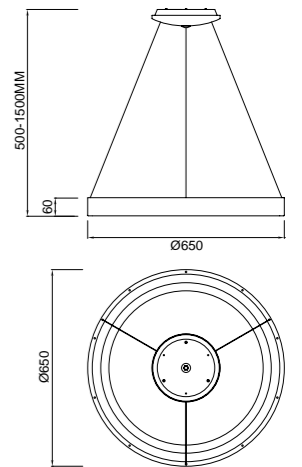

020

REF.5796



REF.5797

## REF.5797 DIMMABLE Colgante - Pendant Lamp



- LED 30W 3000K 2100lm - 220/240V
- Metal Blanco Mate - White Metal Matt
- Difusor Acrílico - Acrylic Diffuser

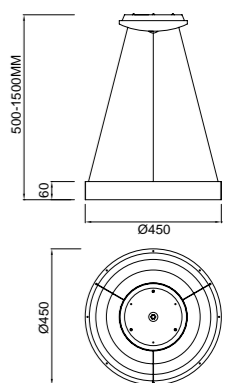

OAMI: 003854025-0002

021

# VERSAILLES





REF.5560



REF.5560



REF.5561



REF.5562



REF.5563

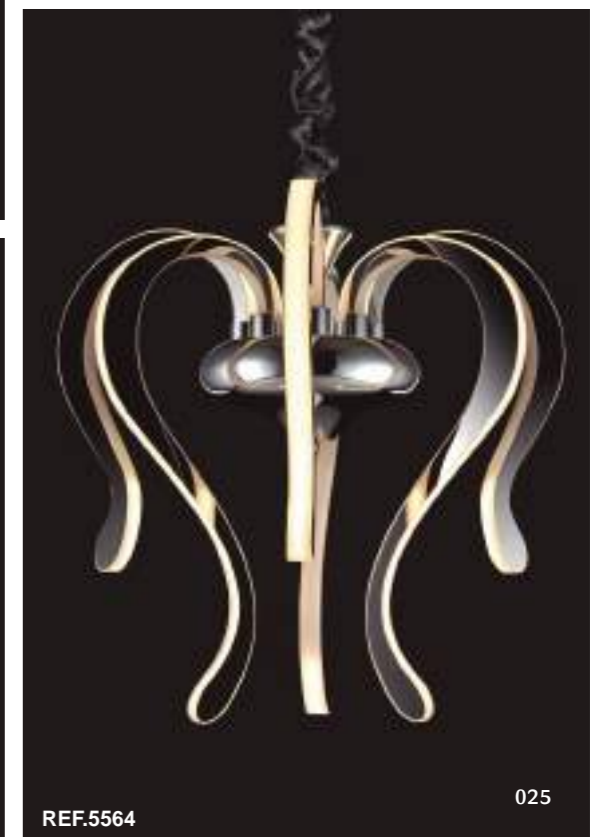

REF.5564

## REF.5560 DIMMABLE Colgante - Pendant Lamp



LED 256W 3000K 12339lm - 220/240V

Cromo - Chrome

Difusor Acrílico - Acrylic Diffuser

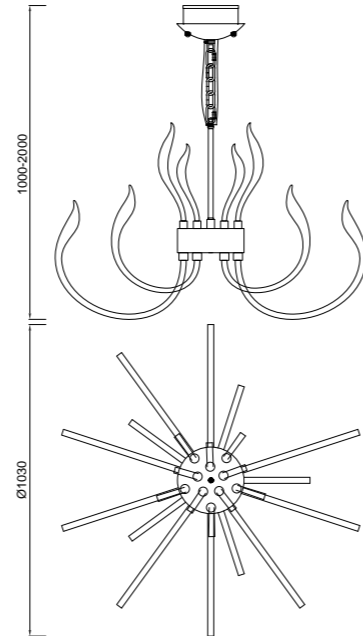
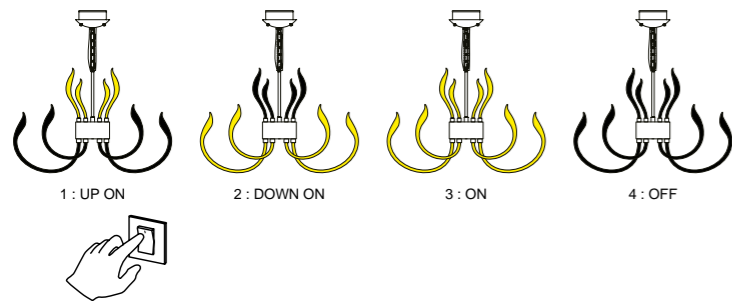

## REF.5561 DIMMABLE Colgante - Pendant Lamp



LED 155W 3000K 7461lm - 220/240V

Cromo - Chrome

Difusor Acrílico - Acrylic Diffuser

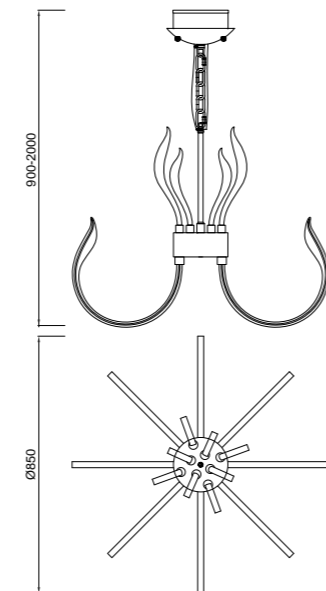
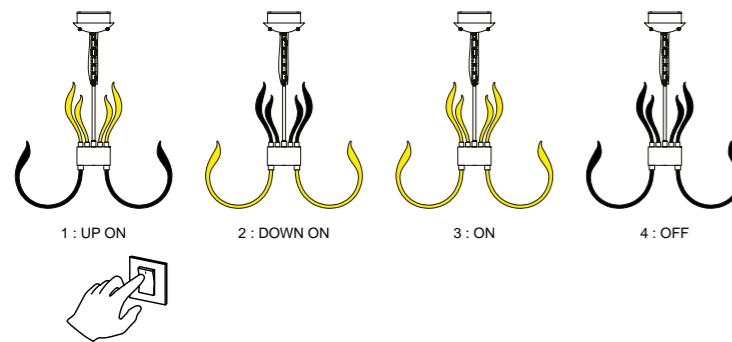

## REF.5562 DIMMABLE Colgante - Pendant Lamp



LED 106W 3000K 5075lm - 220/240V

Cromo - Chrome

Difusor Acrílico - Acrylic Diffuser

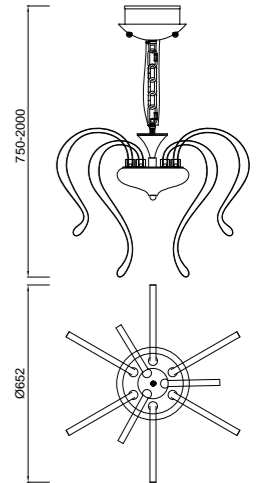
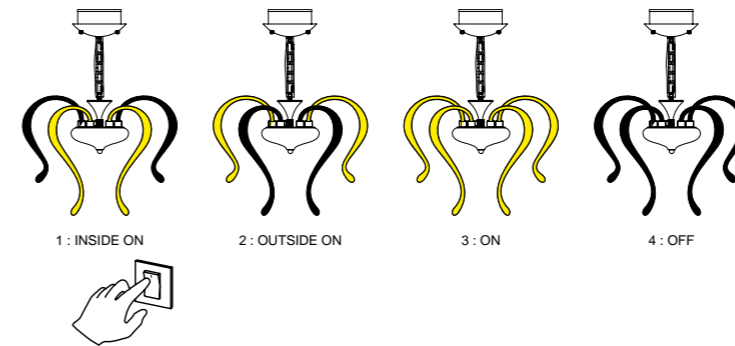

## REF.5563 Colgante - Pendant Lamp



LED 66W 3000K 3166lm - 220/240V

Cromo - Chrome

Difusor Acrílico - Acrylic Diffuser

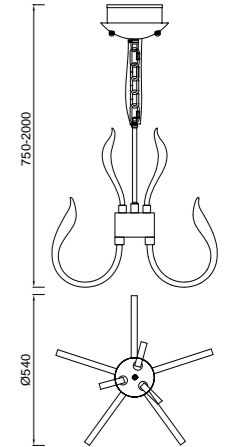

## REF.5564 Colgante - Pendant Lamp



LED 57W 3000K 2733lm - 220/240V

Cromo - Chrome

Difusor Acrílico - Acrylic Diffuser

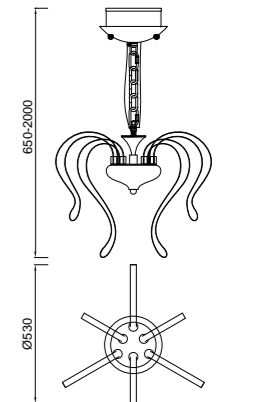

# ZURICH



REF\_5580

REF\_5582



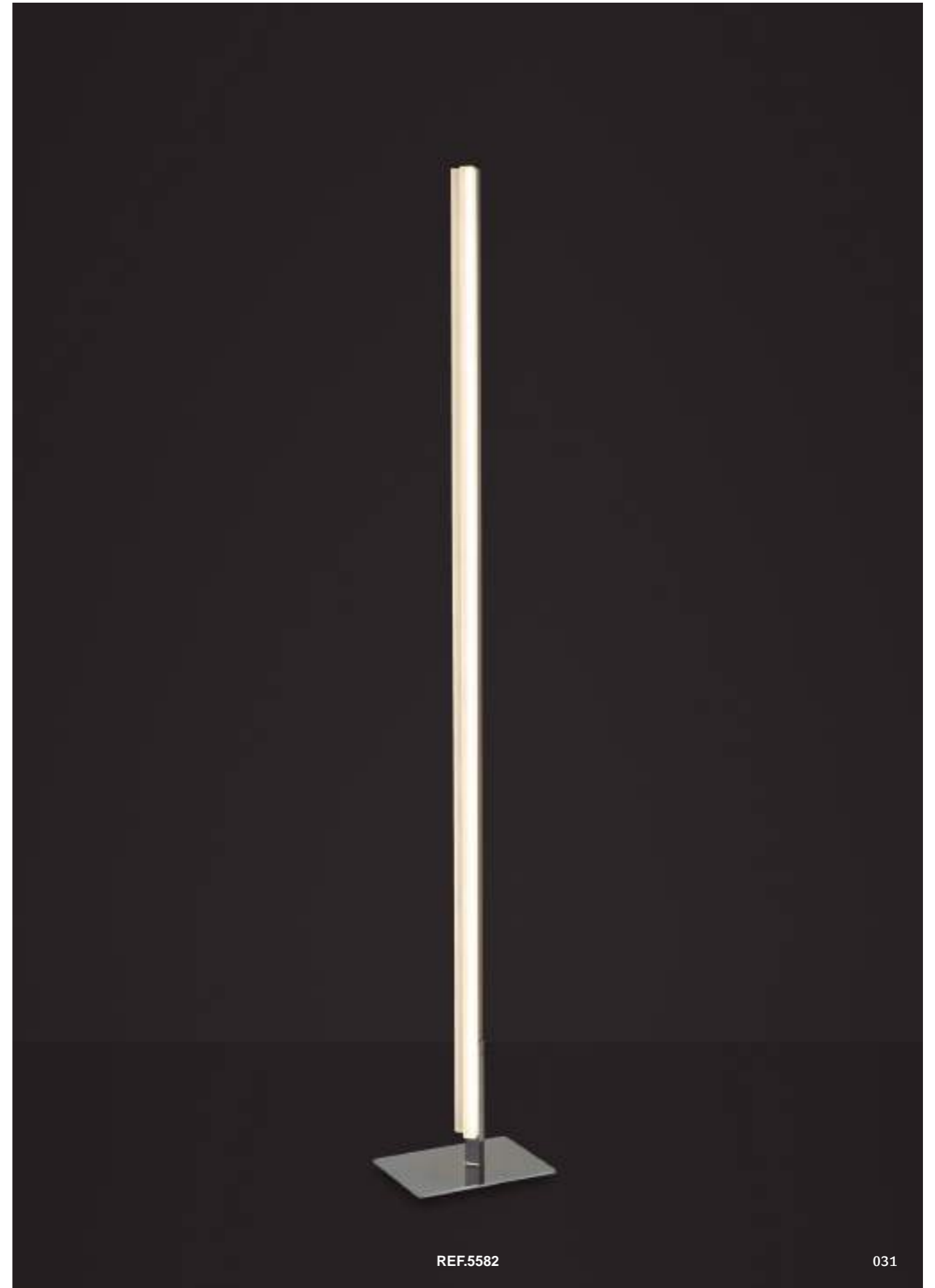



# ZURICH

## REF.5580 Colgante - Pendant Lamp



LED 43W 4000K 2100lm - 100/240V

Acero Inoxidable Satinado - Satin Stainless Steel

Difusor Acrílico - Acrylic Diffuser

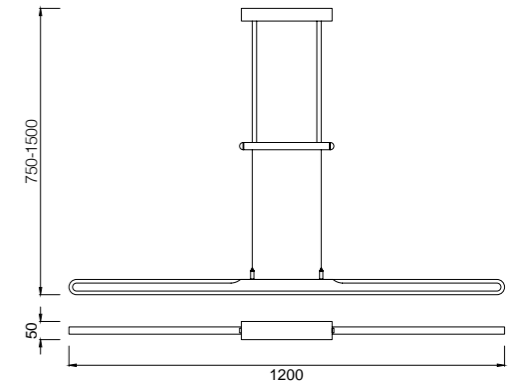

## REF.5581 Aplique - Wall Lamp



LED 43W 4000K 2100lm - 100/240V

Acero Inoxidable Satinado - Satin Stainless Steel

Difusor Acrílico - Acrylic Diffuser

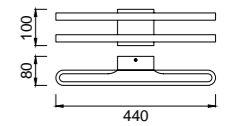

## REF.5582 Pie de salón - Floor Lamp



LED 43W 4000K 2100lm - 100/240V

Acero Inoxidable Satinado - Satin Stainless Steel

Difusor Acrílico - Acrylic Diffuser

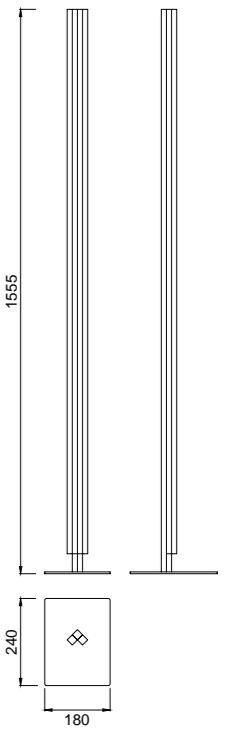
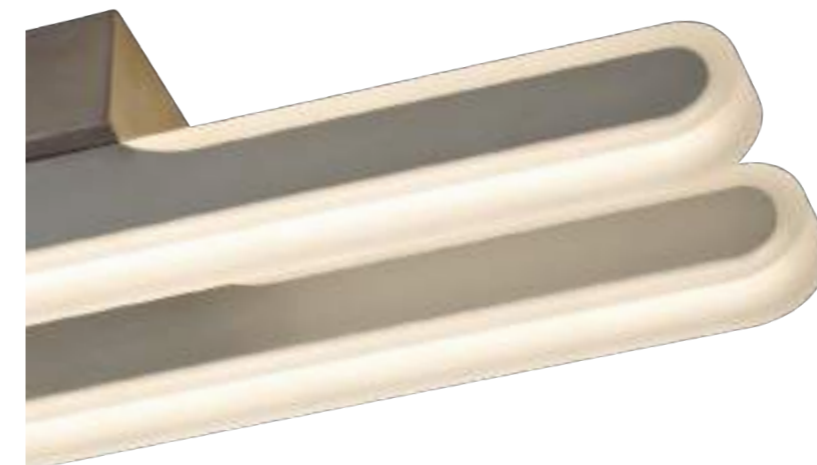

# SURF





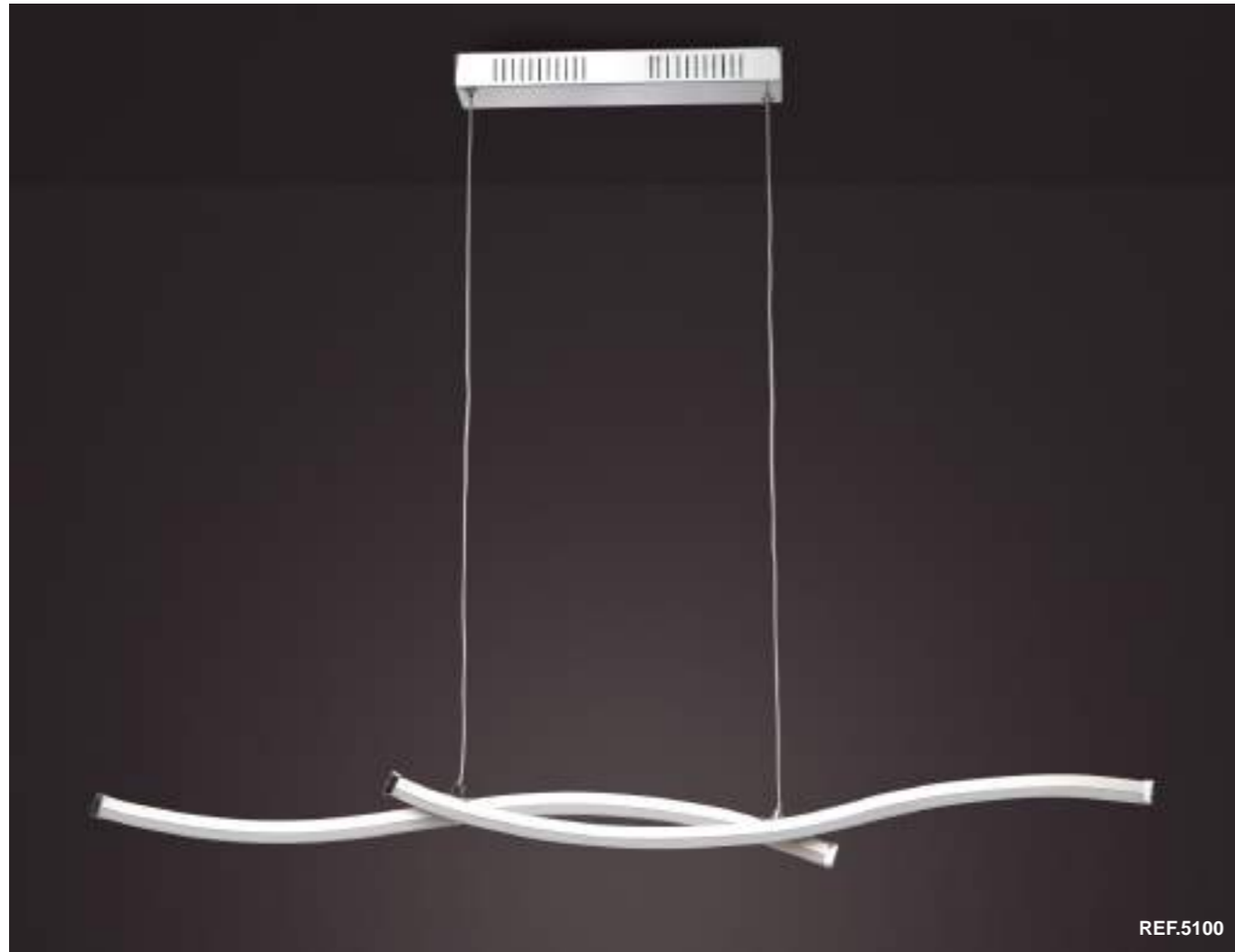

## REF.5100 Colgante - Pendant Lamp



- LED 24W 3000K 1631lm - 100/240V
- Níquel Satinado - Satin Nickel
- Cromo - Chrome
- Difusor Acrílico - Acrylic Diffuser

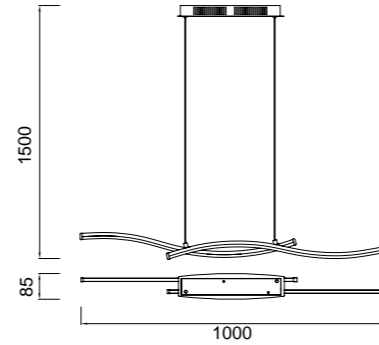

## REF.5101 Plafón - Ceiling Lamp



- LED 26W 3000K 1800lm - 100/240V
- Níquel Satinado - Satin Nickel
- Cromo - Chrome
- Difusor Acrílico - Acrylic Diffuser

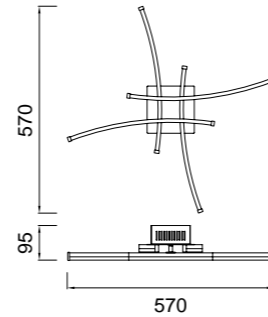

## REF.5102 Aplique - Wall Lamp



- LED 6W 3000K 378lm - 100/240V
- Níquel Satinado - Satin Nickel
- Cromo - Chrome
- Difusor Acrílico - Acrylic Diffuser

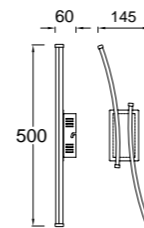

## REF.5103 Sobremesa - Table Lamp



- LED 12W 3000K 784lm - 100/240V
- Níquel Satinado - Satin Nickel
- Cromo - Chrome
- Difusor Acrílico - Acrylic Diffuser

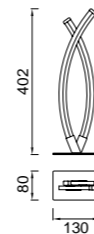

## REF.5104 Pie de Salón - Floor Lamp



- LED 23W 3000K 1590lm - 100/240V
- Níquel Satinado - Satin Nickel
- Cromo - Chrome
- Difusor Acrílico - Acrylic Diffuser

Regulador Intensidad  
Intensity Regulator



Interruptor Táctil - Touch Switch

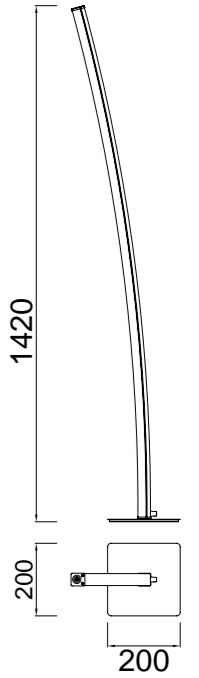

# SWISS





# SWISS

## REF.5602 Colgante - Pendant Lamp



E27 MAX 1x40W - 220/240V (no incl.)

□ Metal Blanco - White Metal

■ Cuero - Leather

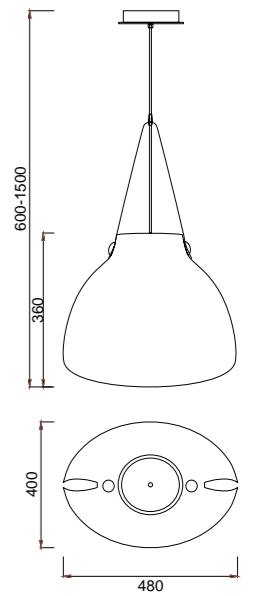

## REF.5601 Colgante - Pendant Lamp



E27 MAX 1x40W - 220/240V (no incl.)

□ Metal Blanco - White Metal

■ Cuero - Leather

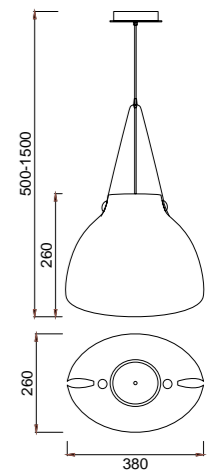

## REF.5600 Colgante - Pendant Lamp



E27 MAX 1x40W - 220/240V (no incl.)

□ Metal Blanco - White Metal

■ Cuero - Leather

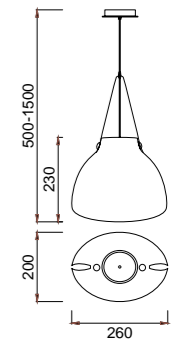



# CUBE





REF.5590



REF.5591



REF.5592



REF.5593

# CUBE

DATOS TÉCNICOS / TECHNICAL DATA

## REF.5590 Colgante - Pendant Lamp



E27 MAX 1x40W - 220/240V (no incl.)

Metal Blanco Mate - Matt White Metal

Madera - Wood

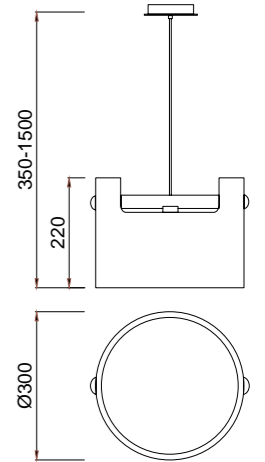

## REF.5591 Colgante - Pendant Lamp



E27 MAX 1x40W - 220/240V (no incl.)

Metal Blanco Mate - Matt White Metal

Madera - Wood

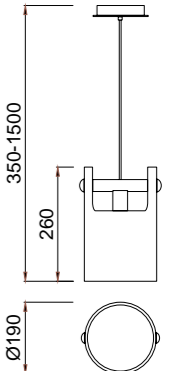

## REF.5592 Sobremesa - Table Lamp



E27 MAX 1x40W - 220/240V (no incl.)

Metal Blanco Mate - Matt White Metal

Madera - Wood

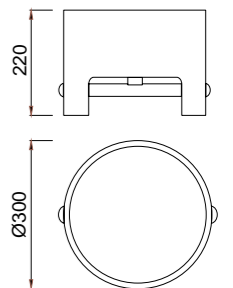

## REF.5593 Sobremesa - Table Lamp



E27 MAX 1x40W - 220/240V (no incl.)

Metal Blanco Mate - Matt White Metal

Madera - Wood

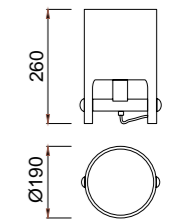

# PETACA







REF.5490



REF.5512

# PETACA

DATOS TÉCNICOS / TECHNICAL DATA

## REF.5512 Plafón - Ceiling Lamp



LED 47W 3000K 2850lm - 220/240V

Metal Blanco Mate - White Metal Matt

Difusor Acrílico - Acrylic Diffuser

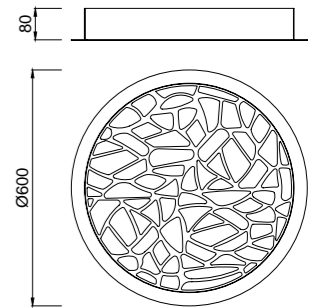

## REF.5511 Aplique - Wall Lamp



LED 8W 3000K 480lm - 220/240V

Metal Blanco Mate - White Metal Matt

Difusor Acrílico - Acrylic Diffuser

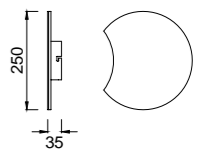

## REF.5491 Aplique - Wall Lamp



LED 12W 3000K 624lm - 220/240V

Metal Blanco Mate - White Metal Matt

Difusor Acrílico - Acrylic Diffuser

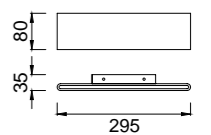

## REF.5490 Colgante - Pendant Lamp



LED 40W 3000K 2080lm - 220/240V

Metal Blanco Mate - White Metal Matt

Difusor Acrílico - Acrylic Diffuser

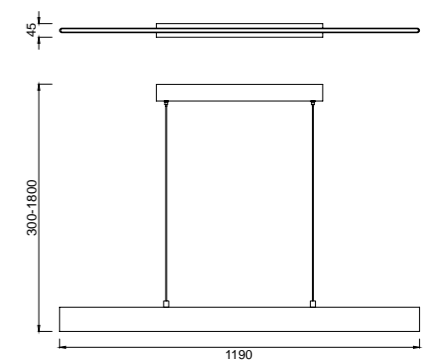

# ARGENTA





## REF.4842E-4843E Colgante - Pendant Lamp



### REF.4842E

E27 MAX 5x13W - 220/240V (no incl.)

Metal blanco - White metal / Plata - Silver

Difusor Acrílico - Acrylic Diffuser

Cable blanco - White wire

### REF.4843E

E27 MAX 5x13W - 220/240V (no incl.)

Metal negro - Black metal / Plata - Silver

Difusor Acrílico - Acrylic Diffuser

Cable negro - Black wire

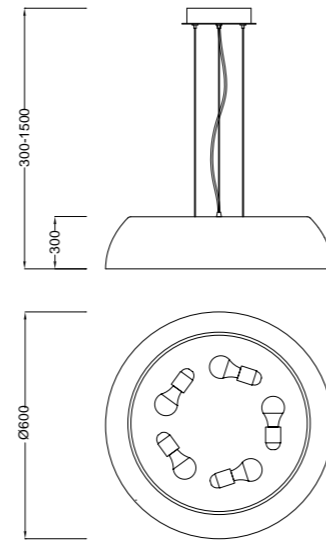

## REF.4840E-4841E Colgante - Pendant Lamp



### REF.4840E

E27 MAX 3x13W - 220/240V (no incl.)

Metal blanco - White metal / Plata - Silver

Difusor Acrílico - Acrylic Diffuser

Cable blanco - White wire

### REF.4841E

E27 MAX 3x13W - 220/240V (no incl.)

Metal negro - Black metal / Plata - Silver

Difusor Acrílico - Acrylic Diffuser

Cable negro - Black wire

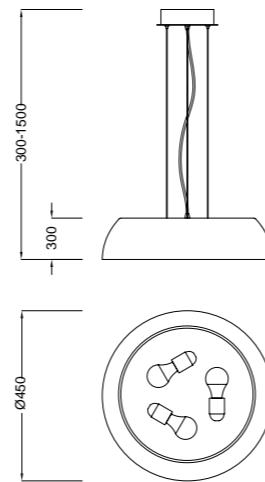

## REF.4846E-4848E Plafón - Ceiling Lamp



### REF.4846E

E27 MAX 5x13W - 220/240V (no incl.)

Metal blanco - White metal / Plata - Silver

Difusor Acrílico - Acrylic Diffuser

### REF.4848E

E27 MAX 5x13W - 220/240V (no incl.)

Metal negro - Black metal / Plata - Silver

Difusor Acrílico - Acrylic Diffuser

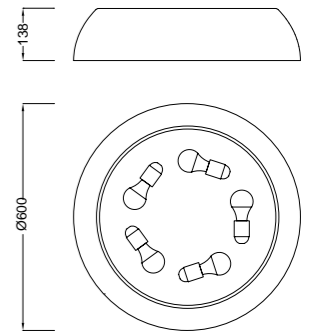

## REF.4847E-4849E Colgante - Pendant Lamp



### REF.4847E

E27 MAX 3x13W - 220/240V (no incl.)

Metal blanco - White metal / Plata - Silver

Difusor Acrílico - Acrylic Diffuser

### REF.4849E

E27 MAX 3x13W - 220/240V (no incl.)

Metal negro - Black metal / Plata - Silver

Difusor Acrílico - Acrylic Diffuser

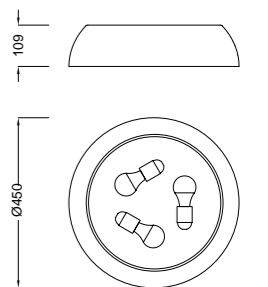



# ZERO



**REF.3673 55W**  
LED 55W 3000K-6500K 4200lm 220-240V

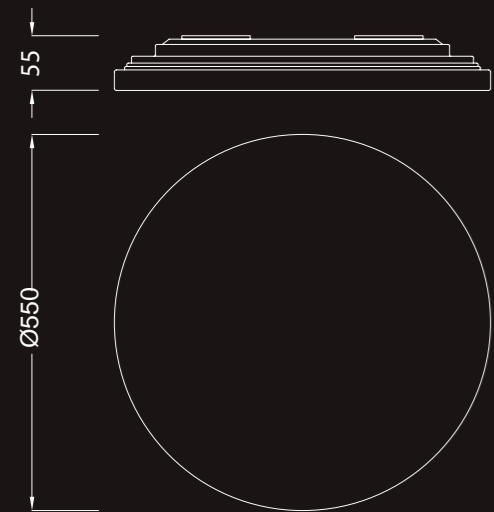

- Mando a distancia para control de:  
Temperatura de color 3000K-6500K.  
Luz dimmable.

- Remote control for:  
Colour temperature 3000K-6500K  
Dimmable light.



# MALDIVAS



**REF.3694 40W**  
LED 40W 3000K-6000K 2800lm 100-240V

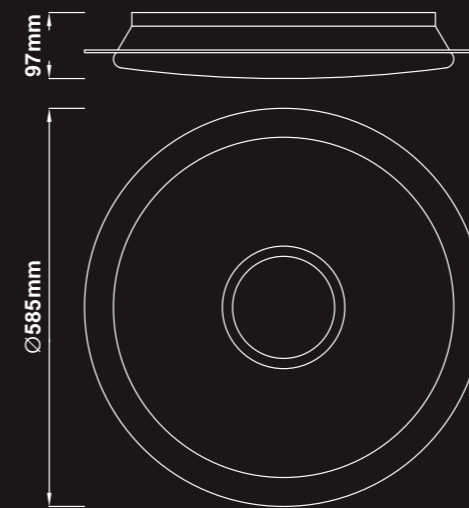

- Mando a distancia para control de:  
Temperatura de color 3000K-6000K.  
Luz dimmable.

- Remote control for:  
Colour temperature 3000K-6000K  
Dimmable light

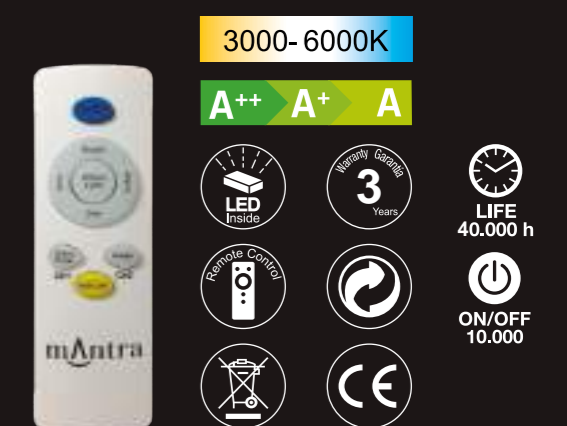

# REEF



**REF.3692 60W**  
LED 60W 3000K-6500K 4200lm 220-240V

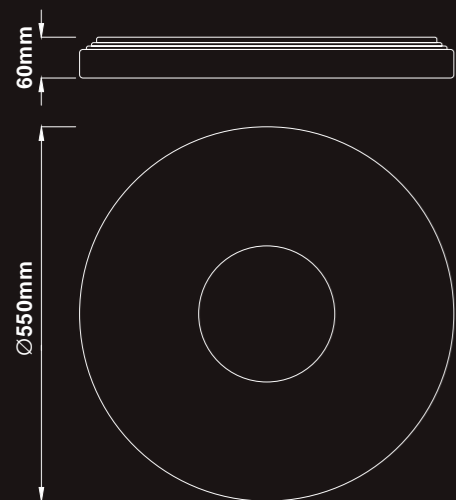

064

- Mando a distancia para control de:  
Temperatura de color 3000K-6500K.  
Luz dimmable.

- Remote control for:  
Colour temperature 3000K-6500K  
Dimmable light.



# REEF



**REF.5933 48W**  
LED 48W 3000K-6500K 3500lm 220-240V

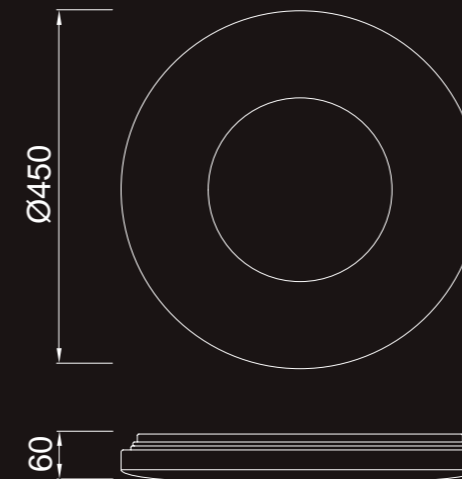

001

- Mando a distancia para control de:  
Temperatura de color 3000K-6500K.  
Luz dimmable.

- Remote control for:  
Colour temperature 3000K-6500K  
Dimmable light.



065

# VIRGIN SAND



**REF.5929 18W**  
LED 18W 3000K-6500K 1680lm 220-240V

- Mando a distancia para control de:  
Temperatura de color 3000K-6500K.  
Luz dimmable.

- Remote control for:  
Colour temperature 2700K-6500K  
Dimmable light.

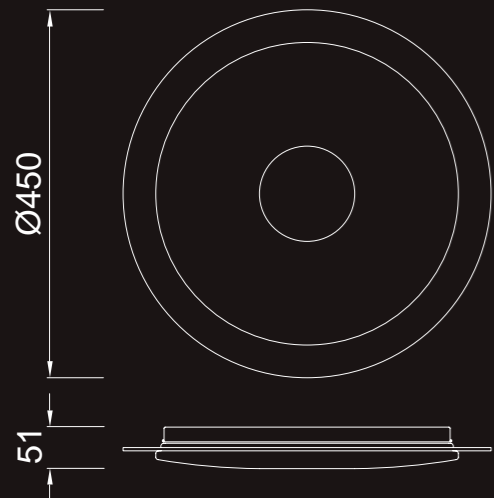

# VIRGIN



**REF.5110 18W**  
LED 18W 2700K-6500K 1680lm 220-240V

- Mando a distancia para control de:  
Temperatura de color 2700K-6500K.  
Luz dimmable.

- Remote control for:  
Colour temperature 2700K-6500K  
Dimmable light.

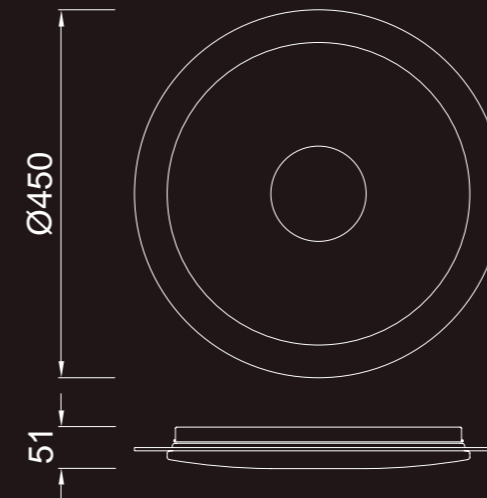

# SPEAKER



## REF.3693 36W

LED 36W 3000K-6000K 2500lm 100-240V

- Conexión bluetooth desde el móvil/tablet para música.
- Mando a distancia para control de:  
Temperatura de color 3000K-6000K.  
Luz dimmable.

- Bluetooth connection with smartphone/tablet.
- Remote control for:  
Colour temperature 3000K-6000K  
Dimmable light.

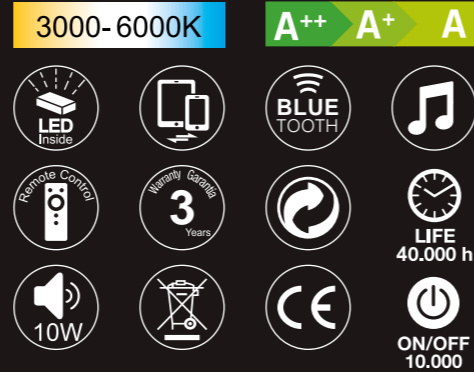
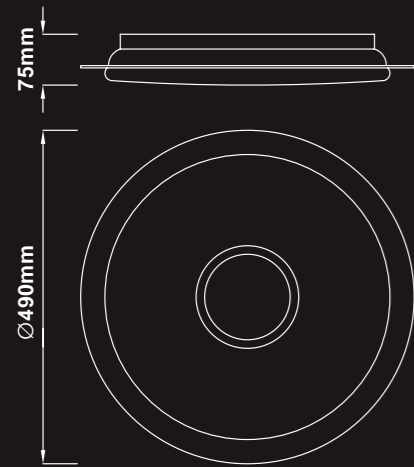

# ONDAS MUSIC



## REF.5878 60W

LED 60W 3000K-6500K 4200lm 220-240V

- Conexión bluetooth desde el móvil/tablet para música.
- Mando a distancia para control de:  
Temperatura de color 3000K-6000K.  
Luz dimmable.

- Bluetooth connection with smartphone/tablet.
- Remote control for:  
Colour temperature 3000K-6500K  
Dimmable light.

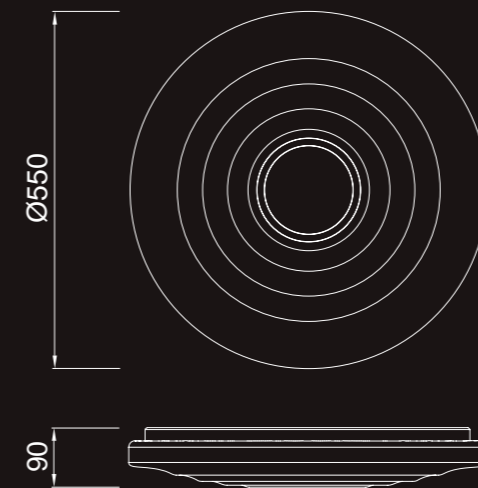

# DIAMANTE



**REF.3679 55W**  
LED 55W 3000K-6500K 4200lm 220-240V

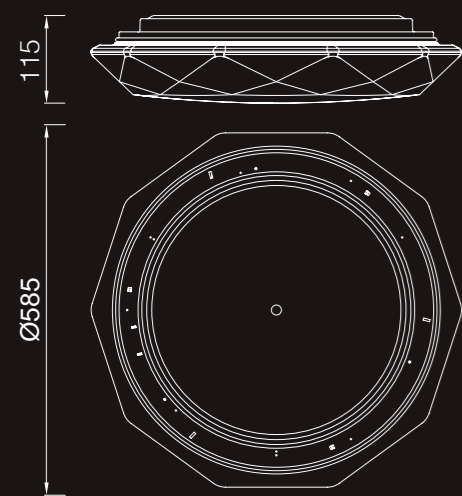

- Mando a distancia para control de:  
Temperatura de color 3000K-6500K.  
Luz dimmable.

- Remote control for:  
Colour temperature 3000K-6500K  
Dimmable light.



# DIAMANTE



**REF.5938 24W**  
LED 24W 3000K-6500K 1400lm 220-240V

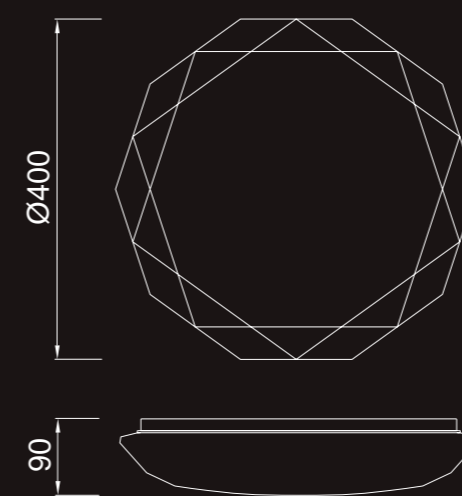

- Mando a distancia para control de:  
Temperatura de color 3000K-6500K.  
Luz dimmable.

- Remote control for:  
Colour temperature 3000K-6500K  
Dimmable light.



# DIAMANTE II



# DIAMANTE II

DATOS TÉCNICOS / TECHNICAL DATA



REF\_5935



REF\_5936

## REF.5935 Plafón - Ceiling Lamp



LED 54W 3000K 3900lm - 220/240V

Difusor Acrílico - Acrylic Diffuser

LUZ  
CÁLIDA  
WARM  
LIGHT

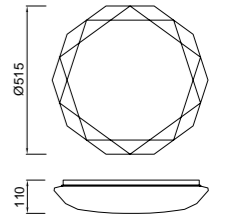

## REF.5970 Plafón - Ceiling Lamp



LED 54W 5000K 4000lm - 220/240V

Difusor Acrílico - Acrylic Diffuser

LUZ  
FRÍA  
COOL  
LIGHT

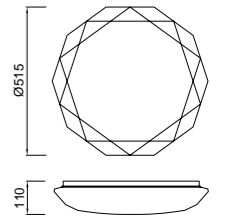

## REF.5936 Plafón - Ceiling Lamp



LED 36W 3000K 2600lm - 220/240V

Difusor Acrílico - Acrylic Diffuser

LUZ  
CÁLIDA  
WARM  
LIGHT

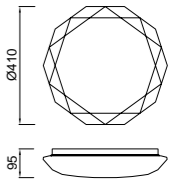

## REF.5971 Plafón - Ceiling Lamp



LED 36W 5000K 2700lm - 220/240V

Difusor Acrílico - Acrylic Diffuser

LUZ  
FRÍA  
COOL  
LIGHT

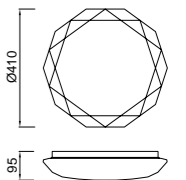

# ZERO II







REF\_5941



REF\_5943



REF\_5945

**REF.5940 Plafón - Ceiling Lamp / REF.5941 Plafón - Ceiling Lamp**



**REF.5940**

- LED 50W 3000K 3700lm - 220/240V
- Difusor Acrílico - Acrylic Diffuser



**REF.5941**

- LED 50W 5000K 3800lm - 220/240V
- Difusor Acrílico - Acrylic Diffuser

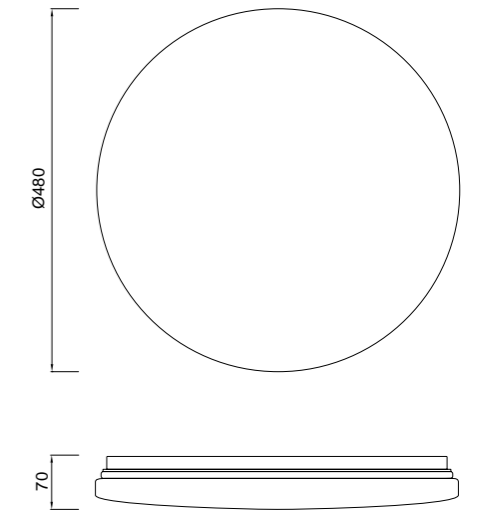

**REF.5942 Plafón - Ceiling Lamp / REF.5943 Plafón - Ceiling Lamp**



**REF.5942**

- LED 36W 3000K 2350lm - 220/240V
- Difusor Acrílico - Acrylic Diffuser



**REF.5943**

- LED 36W 5000K 2450lm - 220/240V
- Difusor Acrílico - Acrylic Diffuser

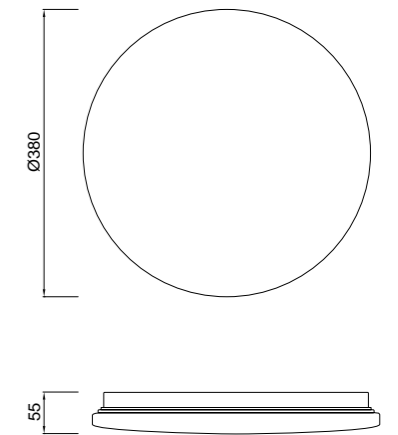

**REF.5944 Plafón - Ceiling Lamp / REF.5945 Plafón - Ceiling Lamp**



**REF.5944**

- LED 24W 3000K 1600lm - 220/240V
- Difusor Acrílico - Acrylic Diffuser



**REF.5945**

- LED 24W 5000K 1700lm - 220/240V
- Difusor Acrílico - Acrylic Diffuser

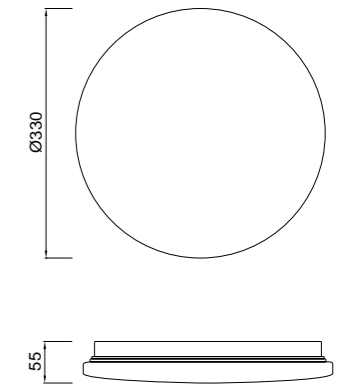

## REF.3677 Plafón - Ceiling Lamp / REF.3678 Plafón - Ceiling Lamp



### REF.3677

LED 60W 3000K 4200lm - 220/240V  
Difusor Acrílico - Acrylic Diffuser



### REF.3678

LED 60W 5000K 4200lm - 220/240V  
Difusor Acrílico - Acrylic Diffuser

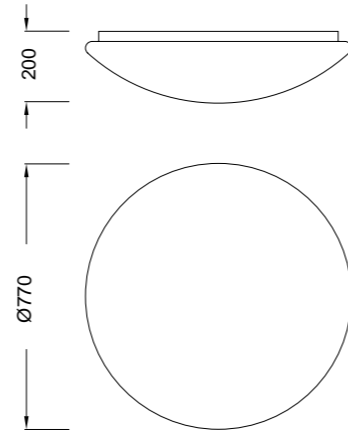

## REF.3691 DIMMABLE Plafón - Ceiling Lamp



LED 60W 3000K-6000K 4200lm - 220/240V  
Difusor acrílico - Acrylic Diffuser

Control Remoto - Remote Control  
Dimable (frío-calor) - Dimable (cool-warm)



3000-6000K

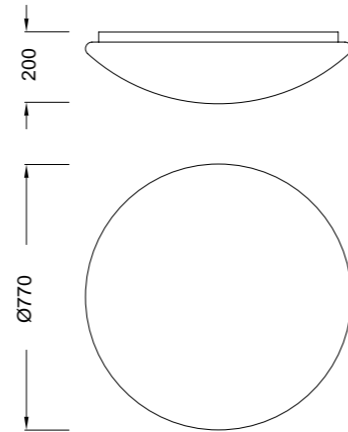

## REF.3673 DIMMABLE Plafón - Ceiling Lamp



LED 55W 3000K-6500K 4200lm - 220/240V  
Difusor acrílico - Acrylic Diffuser

Control Remoto - Remote Control  
Luz Noche - Night Light  
Dimable (frío-calor) - Dimable (cool-warm)



3000-6500K

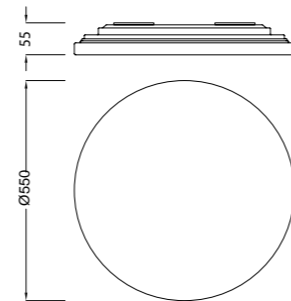

## REF.5410 Plafón - Ceiling Lamp



E27 MAX 5x20W - 220/240V (no incl.)  
Difusor Acrílico - Acrylic Diffuser

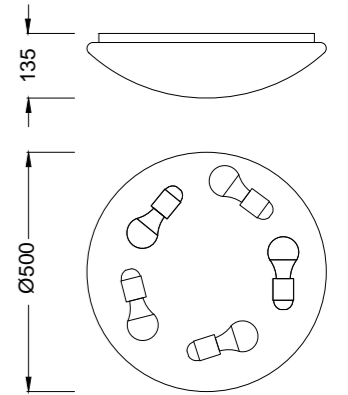

## REF.5411 Plafón - Ceiling Lamp



E27 MAX 3x20W - 220/240V (no incl.)  
Difusor Acrílico - Acrylic Diffuser

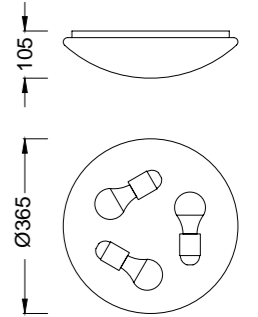

MALE





REF\_5920



REF\_5922

# MALE

## REF.5920 DIMMABLE Plafón - Ceiling Lamp



LED 40W 3000K-6500K 3200lm - 220/240V

Cromo - Chrome

Cristal - Crystal



3000-6500K

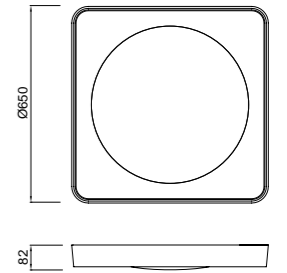

## REF.5921 DIMMABLE Plafón - Ceiling Lamp



LED 24W 3000K-6500K 1920lm - 220/240V

Cromo - Chrome

Cristal - Crystal



3000-6500K

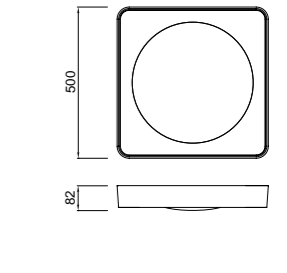

## REF.5922 DIMMABLE Plafón - Ceiling Lamp



LED 40W 3000K-6500K 3200lm - 220/240V

Cromo - Chrome

Cristal - Crystal



3000-6500K

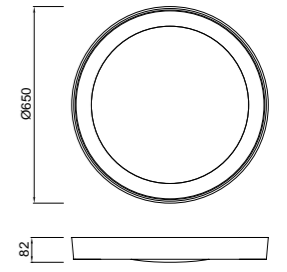

## REF.5923 DIMMABLE Plafón - Ceiling Lamp



LED 24W 3000K-6500K 1920lm - 220/240V

Cromo - Chrome

Cristal - Crystal



3000-6500K

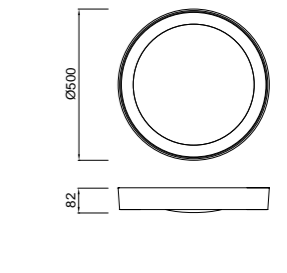

# CENTARA





# CENTARA

## REF.5930 DIMMABLE Plafón - Ceiling Lamp



LED 40W 3000K-6500K 3200lm - 220/240V

Cromo - Chrome

Cristal - Crystal

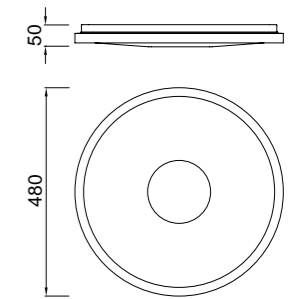

3000-6500K



## REF.5931 DIMMABLE Plafón - Ceiling Lamp



LED 18W 3000K-6500K 1680lm - 220/240V

Cromo - Chrome

Cristal - Crystal

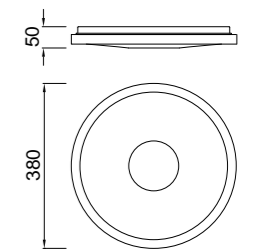

3000-6500K



ARI





REF\_5926

## REF.5925 DIMMABLE Plafón - Ceiling Lamp



LED 40W 3000K-6500K 3200lm - 220/240V

Blanco - White

Cristal - Crystal



3000-6500K

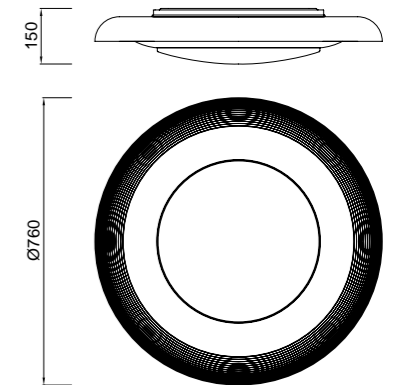

## REF.5926 DIMMABLE Plafón - Ceiling Lamp



LED 24W 3000K-6500K 1920lm - 220/240V

Blanco - White

Cristal - Crystal



3000-6500K

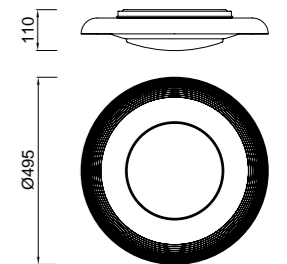

REF\_5927

## REF.5927 Plafón - Ceiling Lamp



LED 12W 3000K 960lm - 220/240V

Blanco - White

Cristal - Crystal

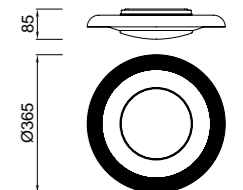



# REFLEX





REF.5341



REF.5344



REF.5342

# REFLEX

DATOS TÉCNICOS / TECHNICAL DATA

## REF.5340 Plafón - Ceiling Lamp



LED 50W 3000K&6000K 3120lm - 220/240V

Niquel Satinado - Satin Nickel

Difusor Acrílico - Acrylic Diffuser

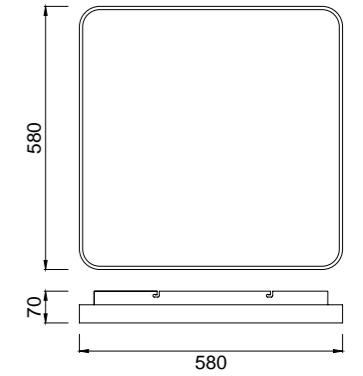

## REF.5342 Plafón - Ceiling Lamp



LED 50W 3000K&6000K 3120lm - 220/240V

Niquel Satinado - Satin Nickel

Difusor Acrílico - Acrylic Diffuser

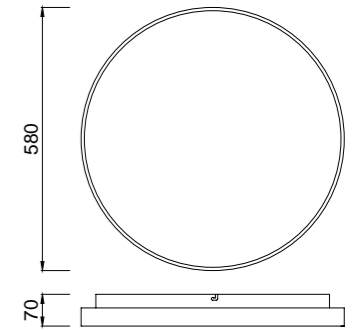

## REF.5341 Plafón - Ceiling Lamp



LED 18W 3000K&6000K 1180lm - 220/240V

Niquel Satinado - Satin Nickel

Difusor Acrílico - Acrylic Diffuser

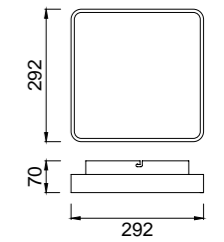

## REF.5344 Plafón - Ceiling Lamp



LED 18W 3000K&6000K 1180lm - 220/240V

Niquel Satinado - Satin Nickel

Difusor Acrílico - Acrylic Diffuser

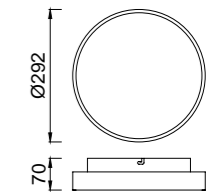

# LADY





# LADY

**REF.6040 DIMMABLE** Sobremesa/Espejo - Table Lamp/Mirror



LED 6W 3000K / 4000K / 5000K 400lm - DC 12V/0.4A

Blanco - White



3000-4000-5000K

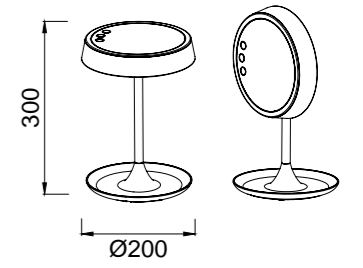

# READING







## REF.5670 Sobremesa - Table Lamp



LED 3,2W 5000K-6500K 120lm - DC5V/1A

Blanco - White

- Sobremesa Articulado.
- Articulated Table Lamp.

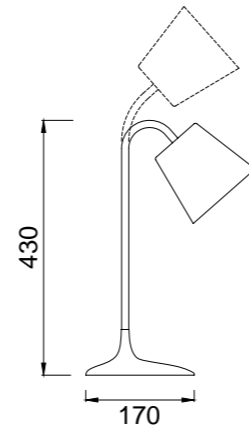

## REF.5671 Sobremesa - Table Lamp



LED 3,5W 2700K-5500K 250lm - DC5V/1A

Blanco - White

- Sobremesa Articulado.
- Función Temporizador.

- Articulated Table Lamp.
- Timer function.

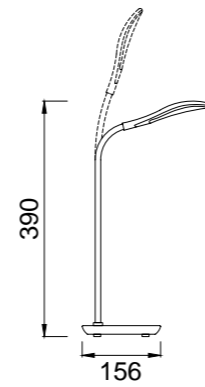

## REF.5672 Sobremesa - Table Lamp



LED 6W 2700K-5500K 170lm - DC5V/1A

Blanco - White

- Sobremesa Articulado.
- Ventilador Incluido 3W.
- Función Temporizador.

- Articulated Table Lamp.
- Fan Include 3W.
- Timer function.

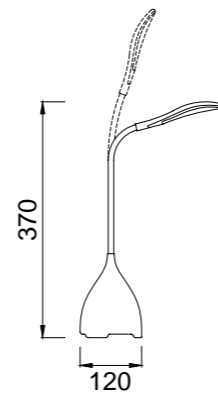

## REF.5673 Sobremesa - Table Lamp



LED 2,5W 5000K 120lm - DC5V/1A

Blanco - White

- Sobremesa Articulado.
- Articulated Table Lamp.

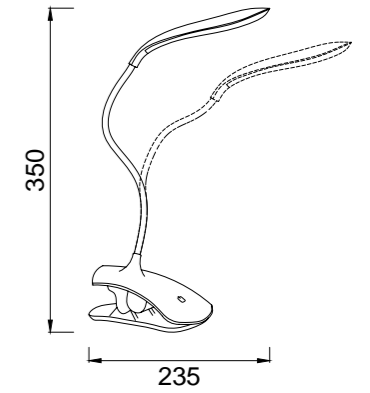

## REF.5674 Sobremesa - Table Lamp



LED 8W 6000K 550lm - 100/240V

Blanco - White

- Sobremesa Articulado.
- Ventilador Incluido 4W.

- Articulated Table Lamp.
- Fan Include 4W.

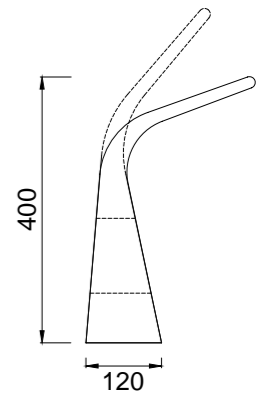



# NATALIA



REF\_5651

REF\_5652-5650



## REF.5650 Sobremesa - Table Lamp



LED 6W 5000K 540lm - 100/240V

■ Negro - Black

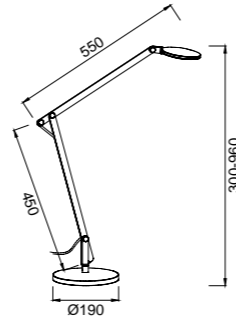

## REF.5655 Pie de salón - Floor Lamp



LED 6W 5000K 540lm - 100/240V

■ Negro - Black

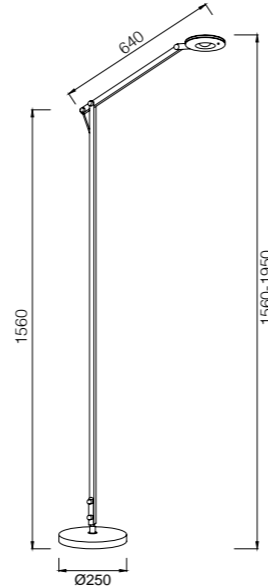

## REF.5651 Sobremesa - Table Lamp



LED 6W 5000K 540lm - 100/240V

□ Blanco - White

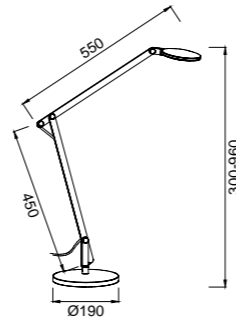

## REF.5656 Pie de salón - Floor Lamp



LED 6W 5000K 540lm - 100/240V

□ Blanco - White

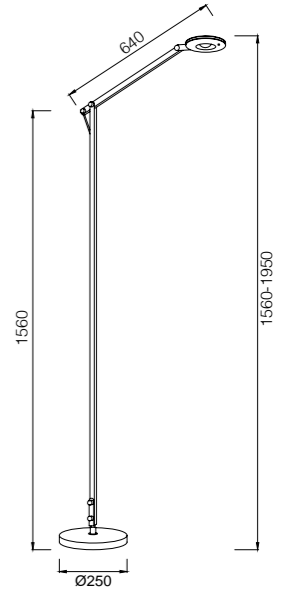

## REF.5652 Sobremesa - Table Lamp



LED 6W 5000K 540lm - 100/240V

■ Plata - Silver

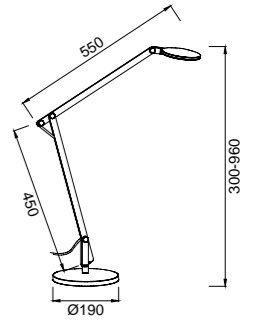

## REF.5657 Pie de salón - Floor Lamp



LED 6W 5000K 540lm - 100/240V

■ Plata - Silver

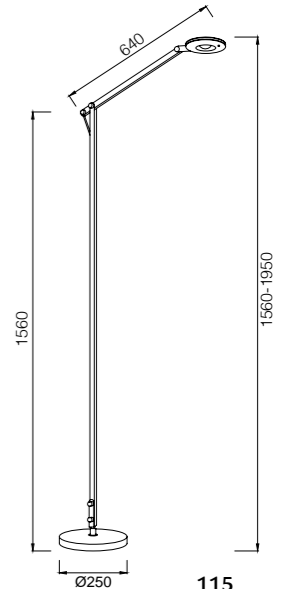

# BOLA





REF\_5710



REF\_5711



REF\_5712



REF\_5713

# BOLA

DATOS TÉCNICOS / TECHNICAL DATA

## REF.5710 Colgante - Pendant Lamp



- E27 MAX 3x40W - 220/240V (no incl.)
- Cromo - Chrome
- Difusor Acrílico - Acrylic Diffuser

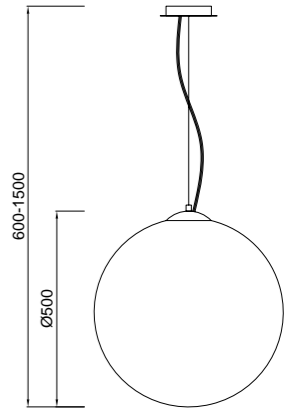

## REF.5711 Colgante - Pendant Lamp



- E27 MAX 1x40W - 220/240V (no incl.)
- Cromo - Chrome
- Difusor Acrílico - Acrylic Diffuser

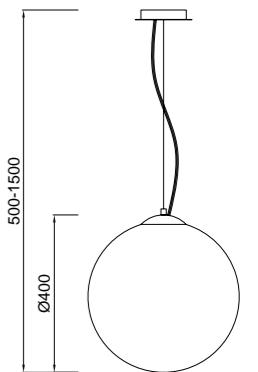

## REF.5712 Colgante - Pendant Lamp



- E27 MAX 1x40W - 220/240V (no incl.)
- Cromo - Chrome
- Difusor Acrílico - Acrylic Diffuser

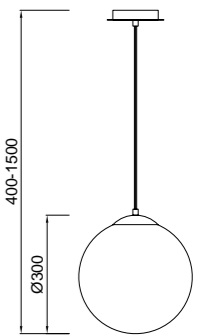

## REF.5713 Sobremesa - Table Lamp



- E27 MAX 1x40W - 220/240V (no incl.)
- Cromo - Chrome
- Difusor Acrílico - Acrylic Diffuser



# BURBUJA





REF\_5790



REF\_5792

## REF.5790 Colgante - Pendant Lamp



- LED 48W 4000K 3360lm - 220/240V
- Cromo - Chrome
- Plata - Silver
- Difusor Acrílico - Acrylic Diffuser

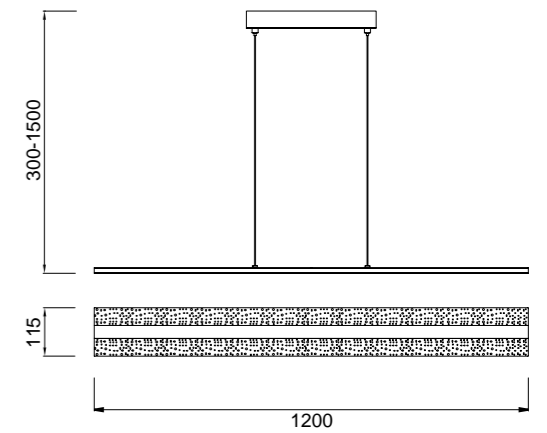

## REF.5792 Semi Plafón - Semi Ceiling Lamp



- LED 30W 4000K 1200lm - 100/250V
- Cromo - Chrome
- Plata - Silver
- Difusor Acrílico - Acrylic Diffuser

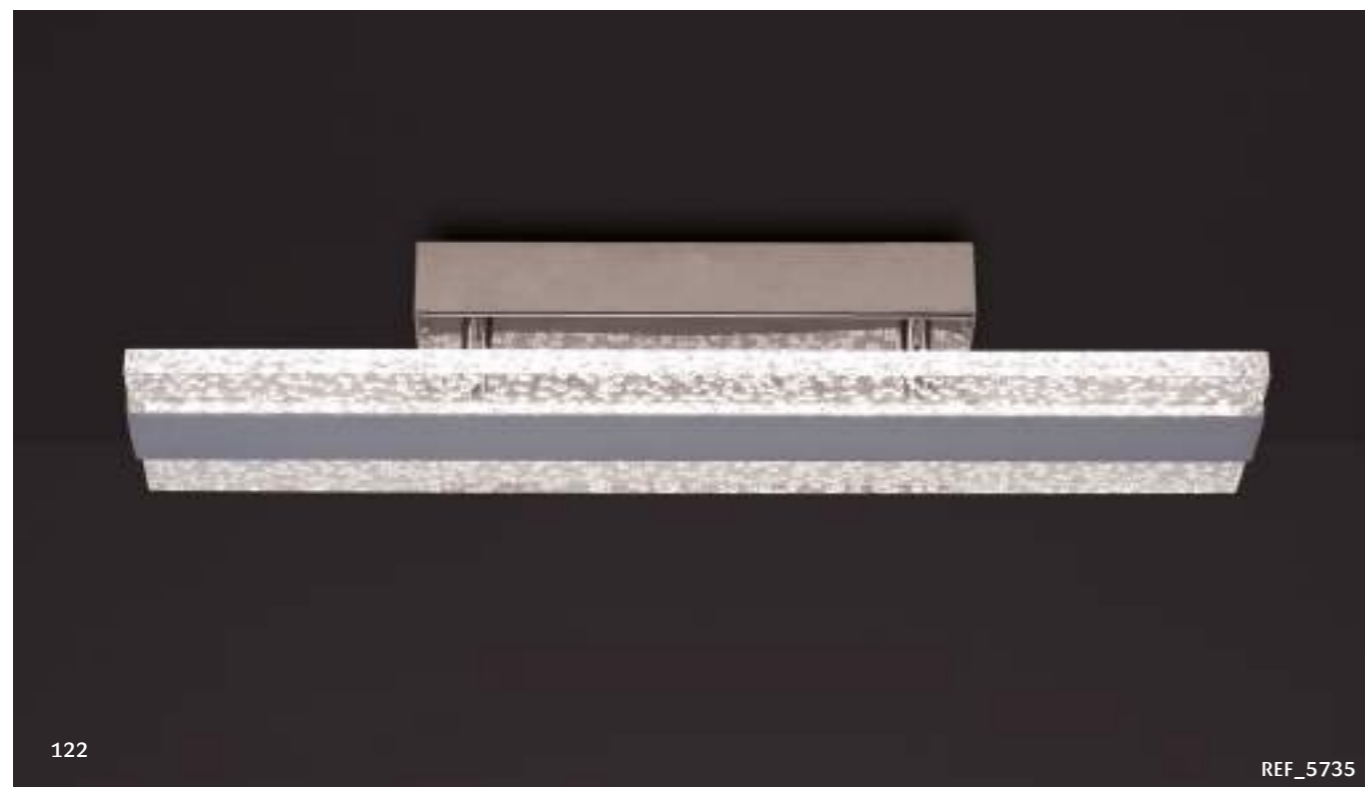
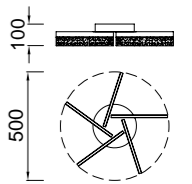

REF\_5735

## REF.5735 Aplique/Plafón - Wall Lamp/Ceiling Lamp



- LED 16W 4000K 1120lm - 220/240V
- Cromo - Chrome
- Plata - Silver
- Difusor Acrílico - Acrylic Diffuser

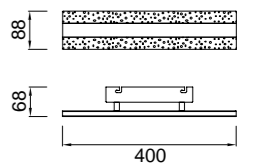

# TUBE







# TUBE

## REF.5532 Aplique/Plafón - Wall/Ceiling Lamp



- LED 21W 4000K 1800lm - 220/240V
- Cromo - Chrome
- Cristal - Glass

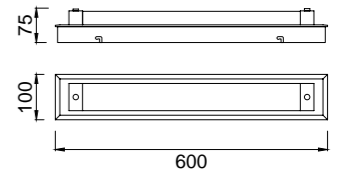

## REF.5533 Aplique/Plafón - Wall/Ceiling Lamp



- LED 13W 4000K 1100lm - 220/240V
- Cromo - Chrome
- Cristal - Glass

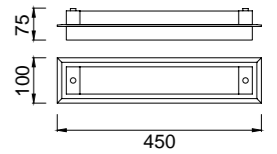

## REF.5534 Aplique/Plafón - Wall/Ceiling Lamp



- LED 8W 4000K 680lm - 220/240V
- Cromo - Chrome
- Cristal - Glass

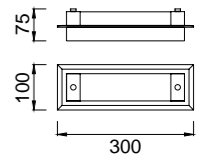

## REF.5530 Colgante - Pendant Lamp



- LED 36W 4000K 2800lm - 220/240V
- Cromo - Chrome
- Cristal - Glass

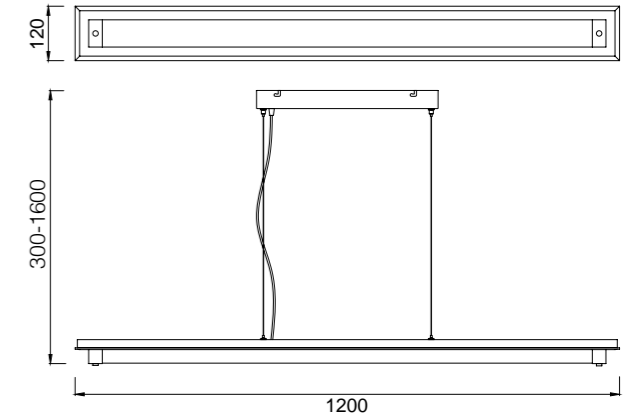

## REF.5531 Colgante - Pendant Lamp



- LED 26W 4000K 2000lm - 220/240V
- Cromo - Chrome
- Cristal - Glass

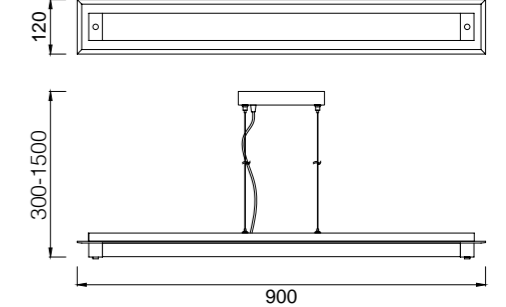

# STRASS



# STRASS

DATOS TÉCNICOS / TECHNICAL DATA

## REF.5885 DIMMABLE Colgante - Pendant Lamp



LED 25W 3000K-6500K 1800lm - 220/240V

Cromo - Chrome

Cristal - Glass



3000-6500K

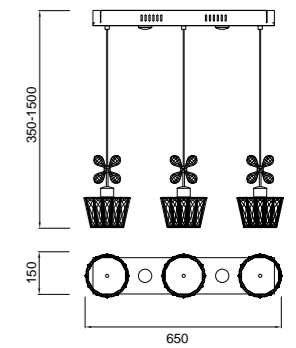

# VINTAGE







## REF.4972 Colgante - Pendant Lamp



☛ E27 MAX 1x60W - 220/240V (no incl.)

■ Cuero - Antique brass

■ Cristal fumé - Smoked Glass

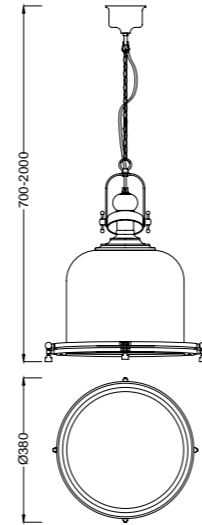

## REF.4971 Colgante - Pendant Lamp



☛ E27 MAX 1x60W - 220/240V (no incl.)

■ Cuero - Antique brass

■ Cristal fumé - Smoked Glass

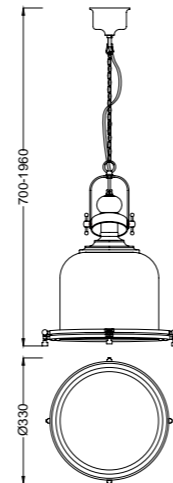

## REF.4970 Colgante - Pendant Lamp



☛ E27 MAX 1x60W - 220/240V (no incl.)

■ Cuero - Antique brass

■ Cristal fumé - Smoked Glass

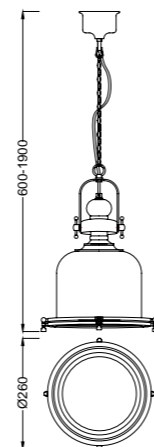

## REF.4975 Colgante - Pendant Lamp



☛ E27 MAX 1x60W - 220/240V (no incl.)

■ Cuero - Antique brass

■ Cristal fumé - Smoked Glass

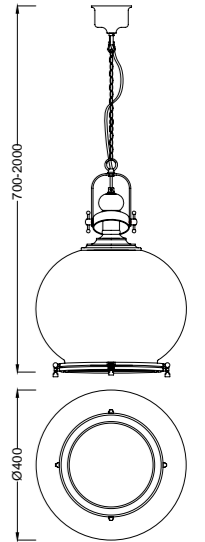

## REF.4974 Colgante - Pendant Lamp



☛ E27 MAX 1x60W - 220/240V (no incl.)

■ Cuero - Antique brass

■ Cristal fumé - Smoked Glass

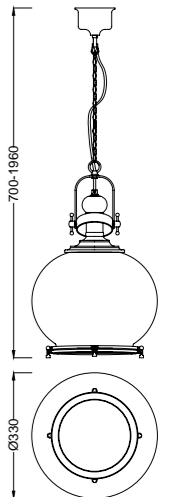

## REF.4973 Colgante - Pendant Lamp



☛ E27 MAX 1x60W - 220/240V (no incl.)

■ Cuero - Antique brass

■ Cristal fumé - Smoked Glass

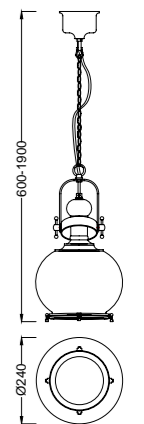

# CORAL





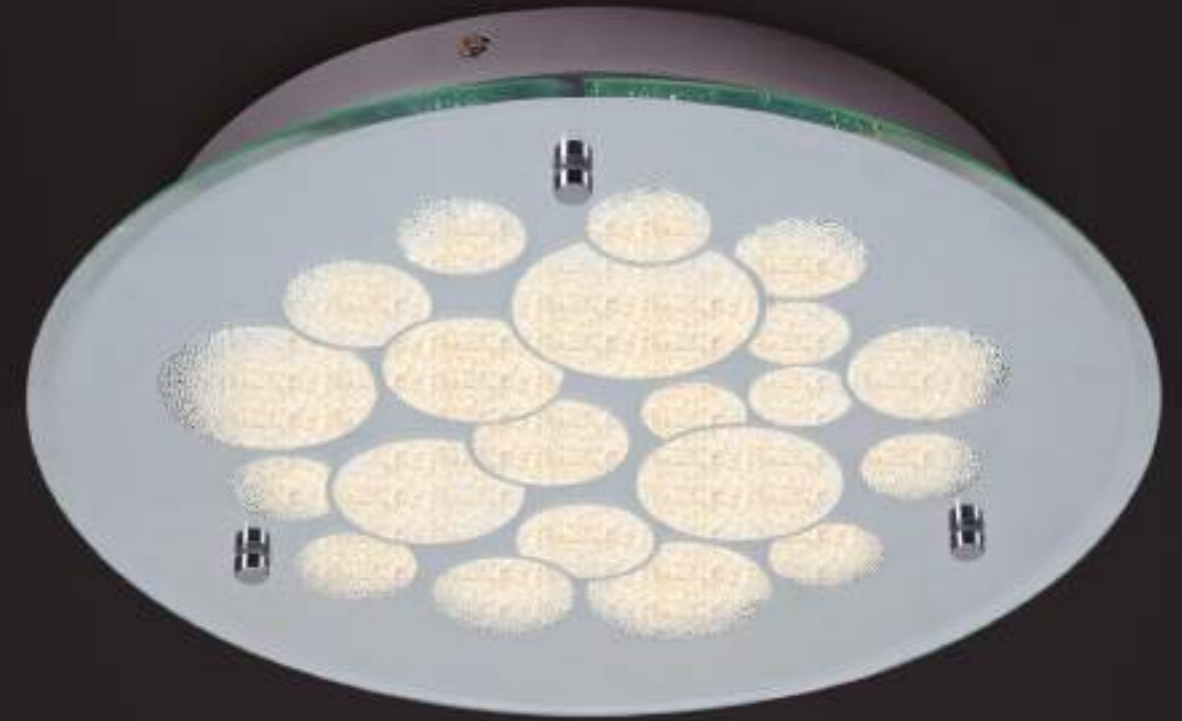

**REF.5550 Plafón - Ceiling Lamp**

LED 23,5W 4000K 940lm - 220/240V

Espejo - Mirror

Cristal - Glass

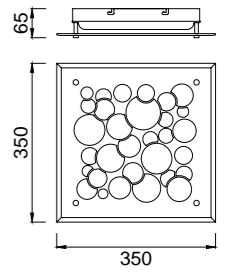
**REF.5551 Plafón - Ceiling Lamp**

LED 15,5W 4000K 620lm - 220/240V

Espejo - Mirror

Cristal - Glass

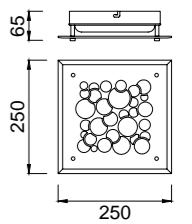
**REF.5552 Plafón - Ceiling Lamp**

LED 23,5W 4000K 940lm - 220/240V

Espejo - Mirror

Cristal - Glass

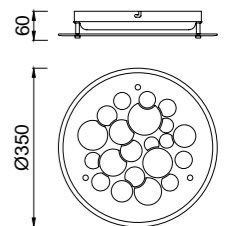
**REF.5553 Plafón - Ceiling Lamp**

LED 15,5W 4000K 620lm - 220/240V

Espejo - Mirror

Cristal - Glass

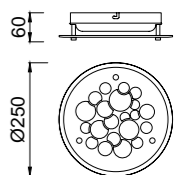

# WINDOWS





REF.5094

## REF.5094 Plafón - Ceiling Lamp

IP20 CE

LED 48W 4000K 3100lm - 220/240V

Difusor Acrílico - Acrylic Diffuser

LUZ  
NATURAL  
NATURAL  
LIGHT

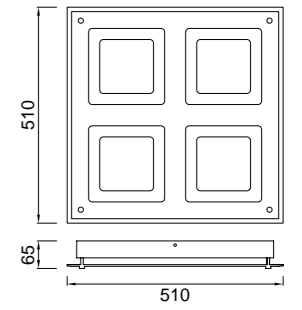

REF.5093

## REF.5093 Plafón - Ceiling Lamp

IP20 CE

LED 24W 4000K 1350lm - 220/240V

Cristal - Glass

Cromo - Chrome

LUZ  
NATURAL  
NATURAL  
LIGHT

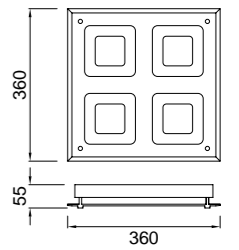

# SATURNO



## REF.5115 Plafón - Ceiling Lamp



LED 18W 4000K 1800lm - 220/240V

Cristal - Glass

Cromo - Chrome

LUZ  
NATURAL  
NATURAL  
LIGHT

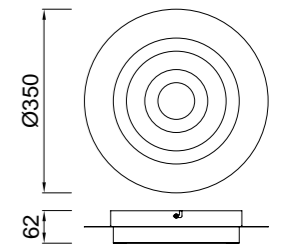

# CRYSTAL LED



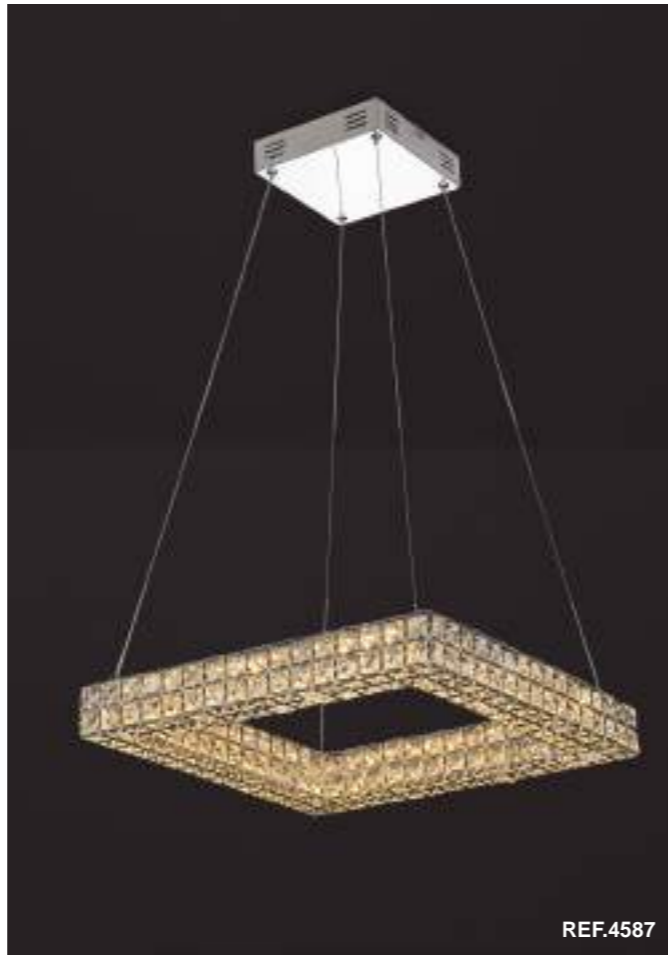





## REF.4583 Plafón - Ceiling Lamp



LED 18W 4000K 1800lm - 100/250V

- Espejo - Mirror
- Cromo - Chrome
- Cristal - Glass

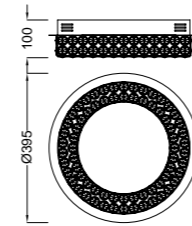

## REF.4586 Plafón - Ceiling Lamp



LED 20W 4000K 2000lm - 100/250V

- Espejo - Mirror
- Cromo - Chrome
- Cristal - Glass

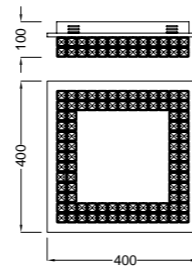

## REF.4584 Colgante - Pendant Lamp



LED 18W 4000K 1800lm - 100/250V

- Cromo - Chrome
- Cristal - Glass

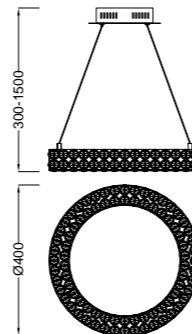

## REF.4585 Colgante - Pendant Lamp



LED 24W 4000K 2400lm - 100/250V

- Cromo - Chrome
- Cristal - Glass

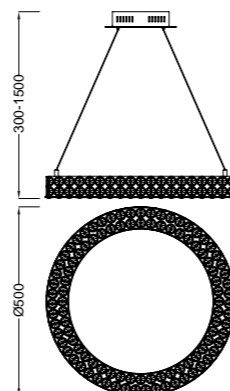

## REF.4587 Colgante - Pendant Lamp



LED 32W 4000K 3200lm - 100/250V

- Cromo - Chrome
- Cristal - Glass

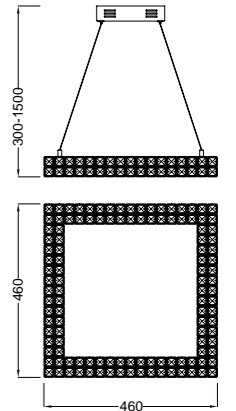

## REF.4570 Plafón - Ceiling Lamp



LED 18W 4000K 1800lm - 220/240V

- Cromo - Chrome
- Cristal - Glass

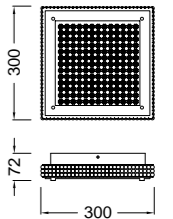

## REF.4571 Plafón - Ceiling Lamp



LED 21W 4000K 2100lm - 220/240V

- Cromo - Chrome
- Cristal - Glass

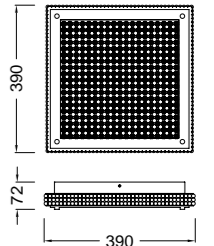

## REF.4572 Plafón - Ceiling Lamp



LED 44W 4000K 4400lm - 100/240V

- Cromo - Chrome
- Cristal - Glass

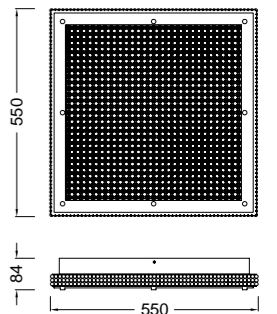

## REF.4573 Colgante - Pendant Lamp



LED 44W 4000K 4400lm - 100/240V

Cromo - Chrome

Cristal - Glass

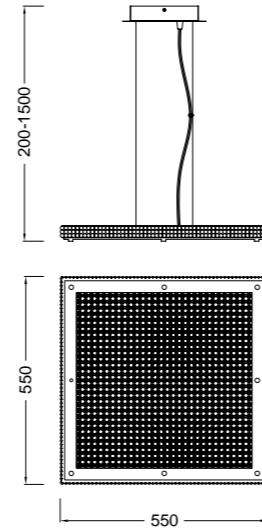

## REF.4574 Plafón - Ceiling Lamp



LED 18W 4000K 1800lm - 220/240V

Cromo - Chrome

Cristal - Glass

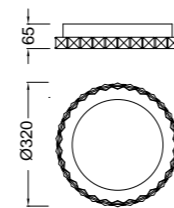

## REF.4575 Plafón - Ceiling Lamp



LED 21W 4000K 2100lm - 220/240V

Cromo - Chrome

Cristal - Glass

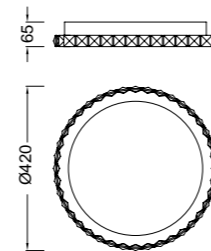

## REF.4576 Plafón - Ceiling Lamp



LED 44W 4000K 4400lm - 100/240V

Cromo - Chrome

Cristal - Glass

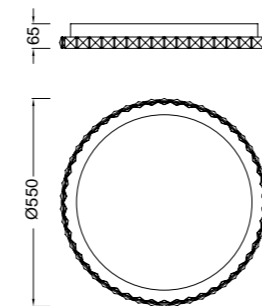

## REF.4577 Colgante - Pendant Lamp



LED 21W 4000K 2100lm - 220/240V

Cromo - Chrome

Cristal - Glass

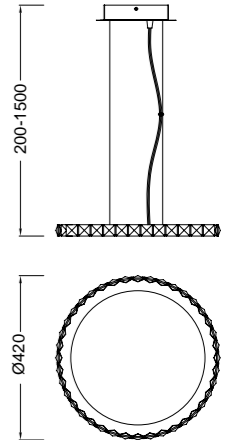

## REF.4578 Colgante - Pendant Lamp



LED 44W 4000K 4400lm - 100/240V

Cromo - Chrome

Cristal - Glass

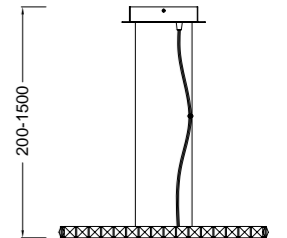

## REF.4579 Colgante - Pendant Lamp



LED 30W 4000K 3000lm - 220/240V

Cromo - Chrome

Cristal - Glass

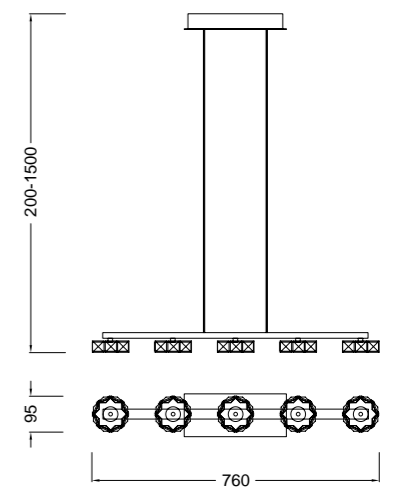

# CRYSTAL LED MIRROR





# CRYSTAL LED MIRROR

DATOS TÉCNICOS / TECHNICAL DATA



## REF.4580 Plafón - Ceiling Lamp

- IP20
- LED 12W 4000K 1200lm - 220/240V
- Espejo - Mirror
- Cromo - Chrome
- Cristal - Glass

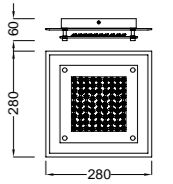

## REF.4581 Plafón - Ceiling Lamp

- IP20
- LED 18W 4000K 1800lm - 220/240V
- Espejo - Mirror
- Cromo - Chrome
- Cristal - Glass

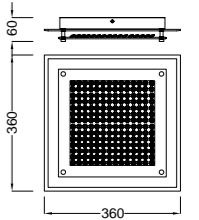

## REF.4582 Plafón - Ceiling Lamp

- IP20
- LED 21W 4000K 2100lm - 220/240V
- Espejo - Mirror
- Cromo - Chrome
- Cristal - Glass

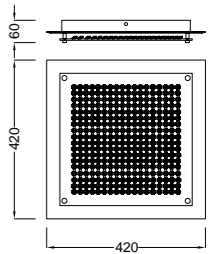

## REF.5090 Plafón - Ceiling Lamp

- IP20
- LED 12W 4000K 1200lm - 220/240V
- Espejo - Mirror
- Cromo - Chrome
- Cristal - Glass

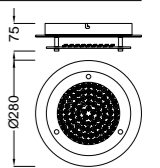

## REF.5091 Plafón - Ceiling Lamp

- IP20
- LED 18W 4000K 1800lm - 220/240V
- Espejo - Mirror
- Cromo - Chrome
- Cristal - Glass

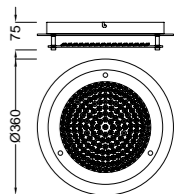

## REF.5092 Plafón - Ceiling Lamp

- IP20
- LED 21W 4000K 2100lm - 220/240V
- Espejo - Mirror
- Cromo - Chrome
- Cristal - Glass

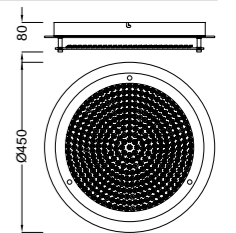

# CRYSTAL



REF\_4607



REF.4600



REF.4601



REF.4602



REF.4603

# CRYSTAL BALLS

DATOS TÉCNICOS / TECHNICAL DATA

## REF.4600 Colgante - Pendant Lamp



G9 MAX 3x43W - 220/240V (no incl.)

Cromo - Chrome

Cristal - Glass

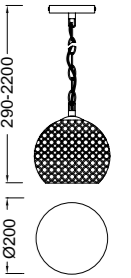

## REF.4601 Colgante - Pendant Lamp



G9 MAX 5x43W - 220/240V (no incl.)

Cromo - Chrome

Cristal - Glass

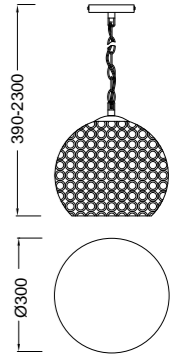

## REF.4602 Colgante - Pendant Lamp



G9 MAX 7x43W - 220/240V (no incl.)

Cromo - Chrome

Cristal - Glass

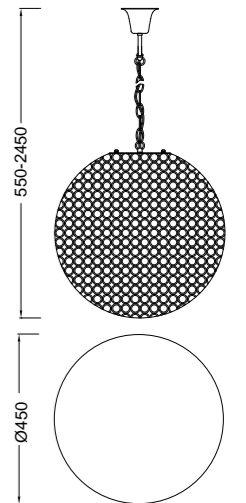





# CRYSTAL BALLS

## REF.4603 Colgante - Pendant Lamp



G9 MAX 9x43W - 220/240V (no incl.)

Cromo - Chrome

Cristal - Glass

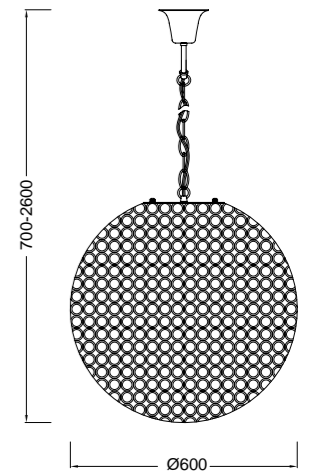

## REF.4604 Colgante - Pendant Lamp



G9 MAX 18x43W - 220/240V (no incl.)

Cromo - Chrome

Cristal - Glass

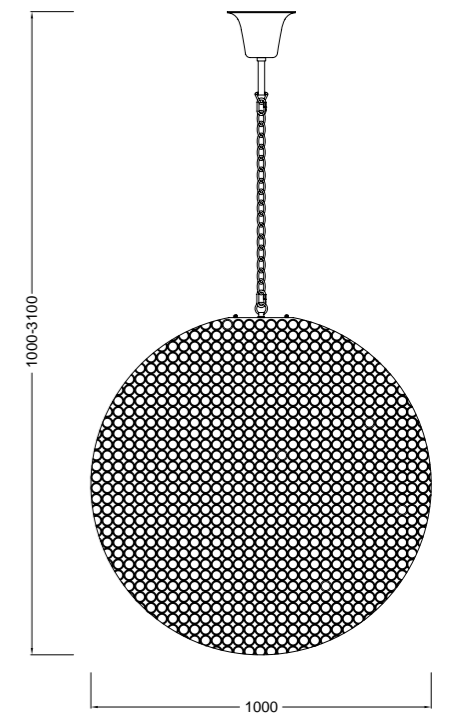

## REF.4605 Aplique - Wall Lamp



G9 MAX 2x43W - 220/240V (no incl.)

Cromo - Chrome

Cristal - Glass

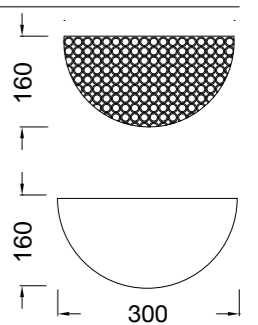



REF.4607

**REF.4607 Colgante - Pendant Lamp**



G9 MAX 9x43W - 220/240V (no incl.)

Cromo - Chrome

Cristal - Glass

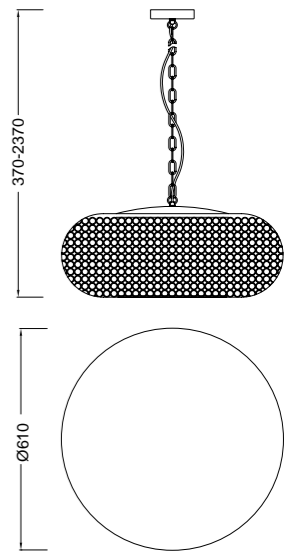

REF.4605



REF.4610

**REF.4608 Plafón - Ceiling Lamp**



G9 MAX 4x43W - 220/240V (no incl.)

Cromo - Chrome

Cristal - Glass

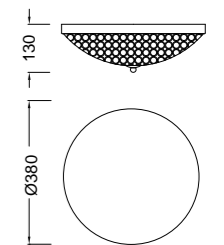

**REF.4609 Plafón - Ceiling Lamp**



G9 MAX 6x43W - 220/240V (no incl.)

Cromo - Chrome

Cristal - Glass

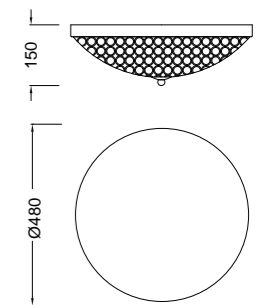

**REF.4610 Plafón - Ceiling Lamp**



G9 MAX 9x43W - 220/240V (no incl.)

Cromo - Chrome

Cristal - Glass

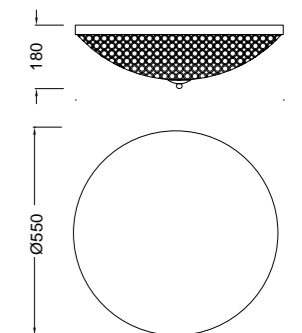

# CRYSTAL G9





REF.4612



REF.4613



# CRYSTAL G9

DATOS TÉCNICOS / TECHNICAL DATA

## REF.4611 Plafón - Ceiling Lamp



- G9 MAX 4x43W - 220/240V
- Cromo - Chrome
- Cristal - Glass

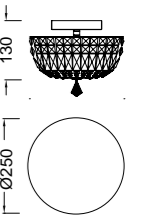

## REF.4612 Plafón - Ceiling Lamp



- G9 MAX 4x43W - 220/240V
- Cromo - Chrome
- Cristal - Glass

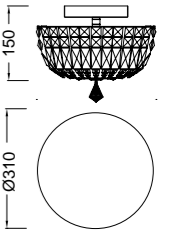

## REF.4613 Plafón - Ceiling Lamp



- G9 MAX 5x43W - 220/240V
- Cromo - Chrome
- Cristal - Glass

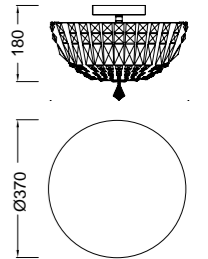

## REF.2332 Plafón - Ceiling Lamp



- G9 MAX 4x43W - 220/240V
- Cromo - Chrome
- Cristal - Glass

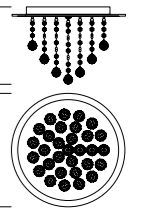

## REF.2331 Plafón - Ceiling Lamp



- G9 MAX 6x43W - 220/240V
- Cromo - Chrome
- Cristal - Glass

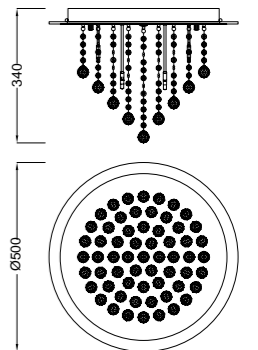

# CRYSTAL BRONCE



# CRYSTAL BRONCE

DATOS TÉCNICOS / TECHNICAL DATA

## REF.4614 Colgante - Pendant Lamp



E27 MAX 1x20W - 220/240V (no incl.)

Cristal Bronze - Bronze Glass

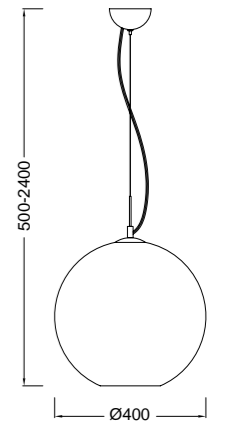

## REF.4615 Colgante - Pendant Lamp



E27 MAX 1x20W - 220/240V (no incl.)

Cristal Bronze - Bronze Glass

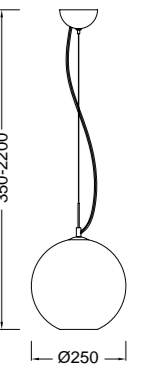

## REF.4616 Colgante - Pendant Lamp



G4 1x20W - 220/240V (incl.)

Cristal Bronze - Bronze Glass

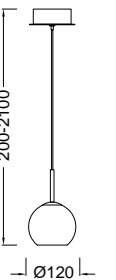

KAWAI







REF.5520



REF.5522



REF.5523









REF.5521

# KAWAI





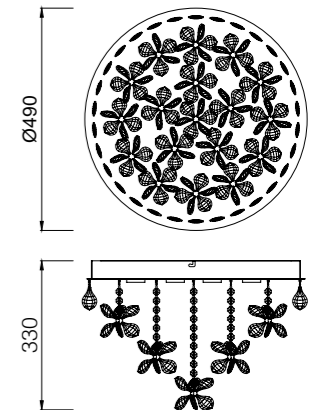

DATOS TÉCNICOS / TECHNICAL DATA

## REF.5520 Plafón - Ceiling Lamp

- IP20    
-  LED 36W 4000K 2100lm - 220/240V
-  Cromo - Chrome
-  Cristal - Glass







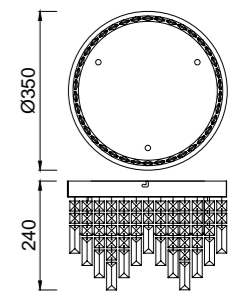

## REF.5522 Plafón - Ceiling Lamp

- IP20    
-  LED 18W 4000K 1400lm - 220/240V
-  Cromo - Chrome
-  Cristal - Glass







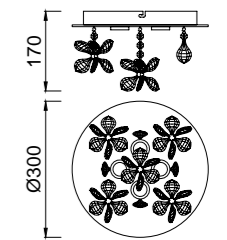

## REF.5523 Plafón - Ceiling Lamp

- IP20    
-  LED 12W 4000K 970lm - 220/240V
-  Cromo - Chrome
-  Cristal - Glass



## REF.5521 Plafón - Ceiling Lamp

- IP20    
-  LED 12W 4000K 950lm - 220/240V
-  Cromo - Chrome
-  Cristal - Glass

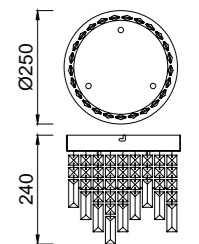

02

Jose I. Ballester



REF\_3921



REF\_3922



REF\_3926



REF\_3923



REF\_3927



REF\_3928



**REF.3921 Colgante - Pendant Lamp - G9**



G9 LED 3x2,5W - 220/240V (incl.)

Cristal - Glass

Cromo - Chrome

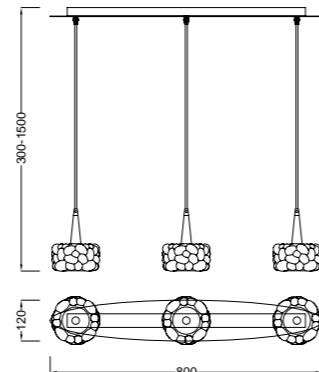

**REF.3922 Colgante - Pendant Lamp - G9**



G9 LED 3x2,5W - 220/240V (incl.)

Cristal - Glass

Cromo - Chrome

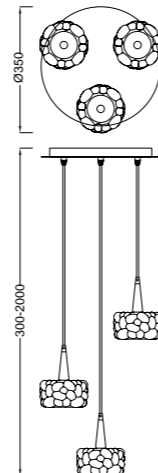

**REF.3923 Colgante - Pendant Lamp - G9**



G9 LED 1x2,5W - 220/240V (incl.)

Cristal - Glass

Cromo - Chrome

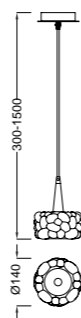

**REF.3926 Plafón - Ceiling Lamp - G9**



G9 LED 1x2,5W - 220/240V (incl.)

Cristal - Glass

Cromo - Chrome

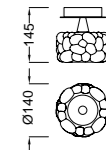

**REF.3927 Aplique - Wall Lamp - G9**



G9 LED 1x2,5W - 220/240V (incl.)

Cristal - Glass

Cromo - Chrome

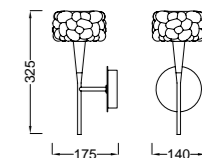

**REF.3928 Sobremesa - Table Lamp - G9**



G9 LED 1x2,5W - 220/240V (incl.)

Cristal - Glass

Cromo - Chrome

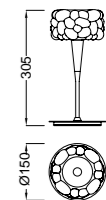

# MAREMAGNUM

Jose I.Ballester & Santiago Sevillano





## REF.3940/4070 Lámpara - Chandelier



3940

- G9 LED 8x2,5W - 220/240V (incl.)
- Cristal - Glass
- Cromo - Chrome

4070

- G9 LED 8x2,5W - 220/240V (incl.)
- Cristal - Glass
- Cuero - Antique Brass

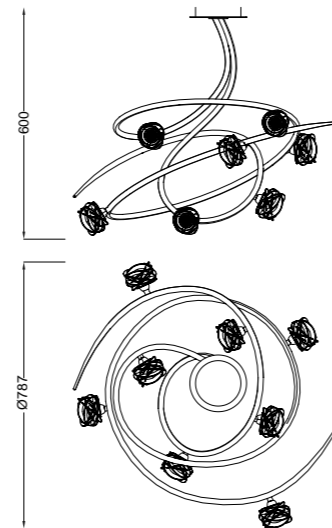

## REF.3941/4071 Lámpara - Chandelier



3941

- G9 LED 6x2,5W - 220/240V (incl.)
- Cristal - Glass
- Cromo - Chrome

4071

- G9 LED 6x2,5W - 220/240V (incl.)
- Cristal - Glass
- Cuero - Antique Brass

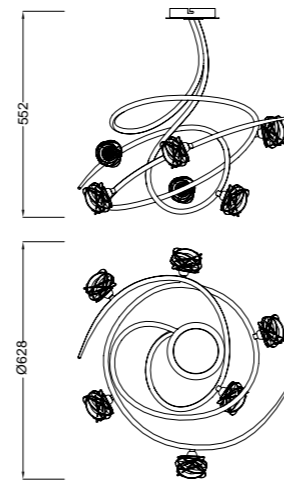

## REF.3942/4072 Lámpara - Chandelier



3942

- G9 LED 6x2,5W - 220/240V (incl.)
- Cristal - Glass
- Cromo - Chrome

4072

- G9 LED 6x2,5W - 220/240V (incl.)
- Cristal - Glass
- Cuero - Antique Brass

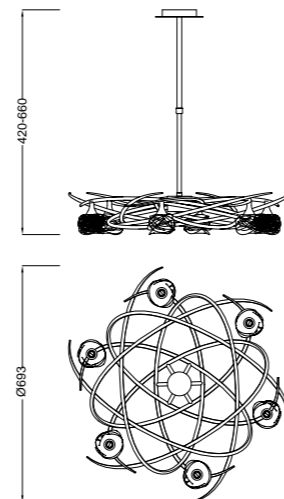

## REF.3943/4073 Semi Plafón - Semi Ceiling Lamp



3943

- G9 LED 4x2,5W - 220/240V (incl.)
- Cristal - Glass
- Cromo - Chrome

4073

- G9 LED 4x2,5W - 220/240V (incl.)
- Cristal - Glass
- Cuero - Antique Brass

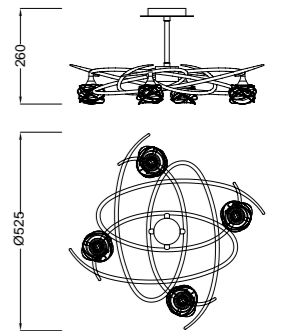

## REF.3944/4074 Semi Plafón - Semi Ceiling Lamp



3944

- G9 LED 3x2,5W - 220/240V (incl.)
- Cristal - Glass
- Cromo - Chrome

4074

- G9 LED 3x2,5W - 220/240V (incl.)
- Cristal - Glass
- Cuero - Antique Brass

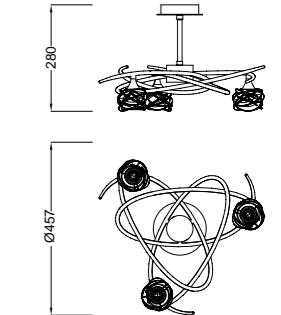

## REF.3947/4077 Aplique - Wall Lamp



3947

- G9 LED 2x2,5W - 220/240V (incl.)
- Cristal - Glass
- Cromo - Chrome

4077

- G9 LED 2x2,5W - 220/240V (incl.)
- Cristal - Glass
- Cuero - Antique Brass

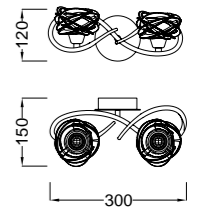

## REF.3948/4078 Aplique - Wall Lamp



3948

- G9 LED 1x2,5W - 220/240V (incl.)
- Cristal - Glass
- Cromo - Chrome

4078

- G9 LED 1x2,5W - 220/240V (incl.)
- Cristal - Glass
- Cuero - Antique Brass

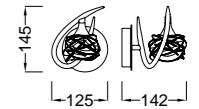

## REF.3949/4079 Sobremesa - Table Lamp



3949

- G9 LED 1x2,5W - 220/240V (incl.)
- Cristal - Glass
- Cromo - Chrome

4079

- G9 LED 1x2,5W - 220/240V (incl.)
- Cristal - Glass
- Cuero - Antique Brass

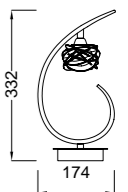

## REF.3945/4075 Plafón - Ceiling Lamp



3945

- G9 LED 1x2,5W - 220/240V (incl.)
- Cristal - Glass
- Cromo - Chrome

4075

- G9 LED 1x2,5W - 220/240V (incl.)
- Cristal - Glass
- Cuero - Antique Brass

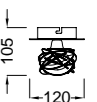

# LOOP

Santiago Sevillano







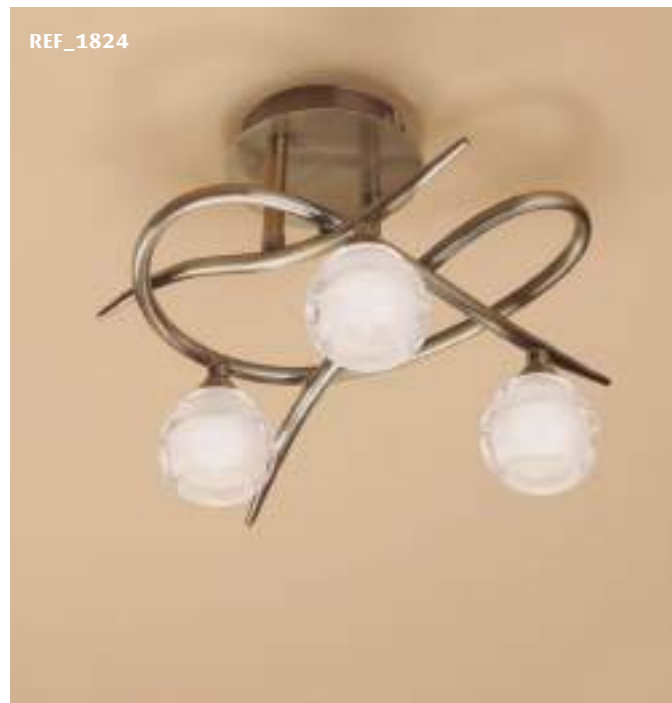

# LOOP

Santiago Sevillano design

DATOS TÉCNICOS / TECHNICAL DATA

## REF.1800/1810/1820 Lámpara - Chandelier



### 1800

G9 LED 8x2,5W - 220/240V (incl.)

Cristal - Glass

Cromo - Chrome

### 1810

G9 LED 8x2,5W - 220/240V (incl.)

Cristal - Glass

Niquel Satinado - Satin Nickel

### 1820

G9 LED 8x2,5W - 220/240V (incl.)

Cristal - Glass

Cuero - Antique Brass

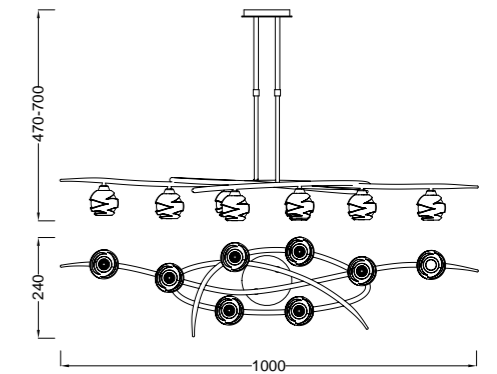

## REF.1801/1811/1821 Lámpara - Chandelier



### 1801

G9 LED 6x2,5W - 220/240V (incl.)

Cristal - Glass

Cromo - Chrome

### 1811

G9 LED 6x2,5W - 220/240V (incl.)

Cristal - Glass

Niquel Satinado - Satin Nickel

### 1821

G9 LED 6x2,5W - 220/240V (incl.)

Cristal - Glass

Cuero - Antique Brass

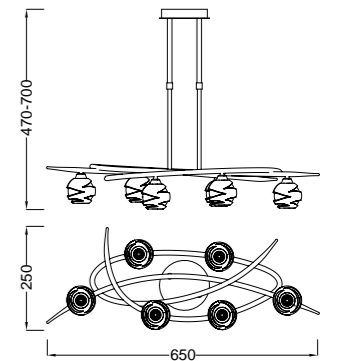

## REF.1802/1812/1822 Semi Plafón - Semi Ceiling Lamp



### 1802

G9 LED 6x2,5W - 220/240V (incl.)

Cristal - Glass

Cromo - Chrome

### 1812

G9 LED 6x2,5W - 220/240V (incl.)

Cristal - Glass

Niquel Satinado - Satin Nickel

### 1822

G9 LED 6x2,5W - 220/240V (incl.)

Cristal - Glass

Cuero - Antique Brass

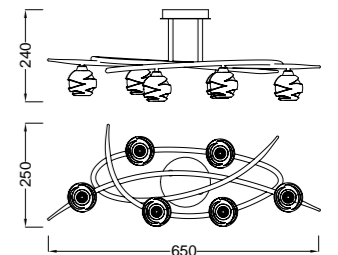

REF.1803/1813/1823 Semi Plafón - Semi Ceiling Lamp



1803

G9 LED 4x2,5W - 220/240V (incl.)

Cristal - Glass

Cromo - Chrome

1813

G9 LED 4x2,5W - 220/240V (incl.)

Cristal - Glass

Niquel Satinado - Satin Nickel

1823

G9 LED 4x2,5W - 220/240V (incl.)

Cristal - Glass

Cuero - Antique Brass

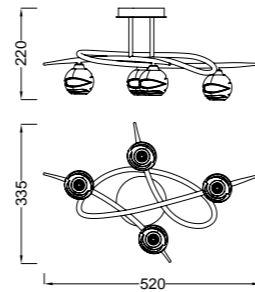

REF.1804/1814/1824 Semi Plafón - Semi Ceiling Lamp



1804

G9 LED 3x2,5W - 220/240V (incl.)

Cristal - Glass

Cromo - Chrome

1814

G9 LED 3x2,5W - 220/240V (incl.)

Cristal - Glass

Niquel Satinado - Satin Nickel

1824

G9 LED 3x2,5W - 220/240V (incl.)

Cristal - Glass

Cuero - Antique Brass

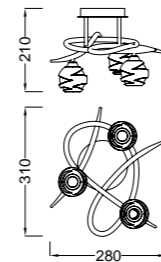

REF.1805/1815/1825 Aplique - Wall Lamp



1805

G9 LED 2x2,5W - 220/240V (incl.)

Cristal - Glass

Cromo - Chrome

1815

G9 LED 2x2,5W - 220/240V (incl.)

Cristal - Glass

Niquel Satinado - Satin Nickel

1825

G9 LED 2x2,5W - 220/240V (incl.)

Cristal - Glass

Cuero - Antique Brass

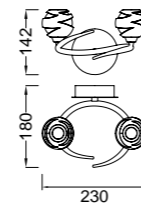

REF.1806/1816/1826 Aplique - Wall Lamp



1806

G9 LED 1x2,5W - 220/240V (incl.)

Cristal - Glass

Cromo - Chrome

1816

G9 LED 1x2,5W - 220/240V (incl.)

Cristal - Glass

Niquel Satinado - Satin Nickel

1826

G9 LED 1x2,5W - 220/240V (incl.)

Cristal - Glass

Cuero - Antique Brass

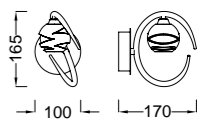

REF.1807/1817/1827 Sobremesa - Table Lamp



1807

G9 LED 1x2,5W - 220/240V (incl.)

Cristal - Glass

Cromo - Chrome

1817

G9 LED 1x2,5W - 220/240V (incl.)

Cristal - Glass

Niquel Satinado - Satin Nickel

1827

G9 LED 1x2,5W - 220/240V (incl.)

Cristal - Glass

Cuero - Antique Brass

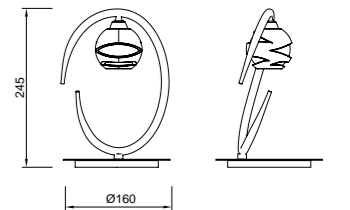

# ZEN

Jose I. Ballester





REF.1424/1434 Lámpara - Chandelier



1424

- G9 LED 8x2,5W - 220/240V (incl.)
- Cristal Óptico - Optical Glass
- Cromo - Chrome

1434

- G9 LED 8x2,5W - 220/240V (incl.)
- Cristal Óptico - Optical Glass
- Cuero - Antique Brass

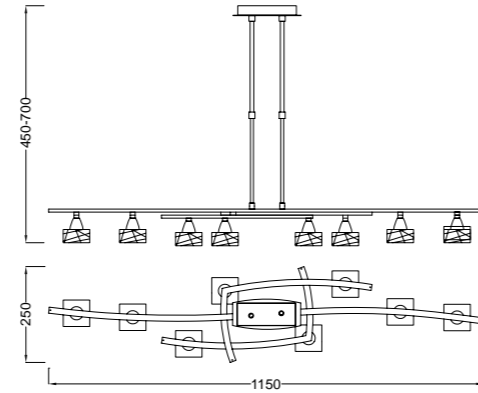

REF.1423/1433 Lámpara - Chandelier



1423

- G9 LED 6x2,5W - 220/240V (incl.)
- Cristal Óptico - Optical Glass
- Cromo - Chrome

1433

- G9 LED 6x2,5W - 220/240V (incl.)
- Cristal Óptico - Optical Glass
- Cuero - Antique Brass

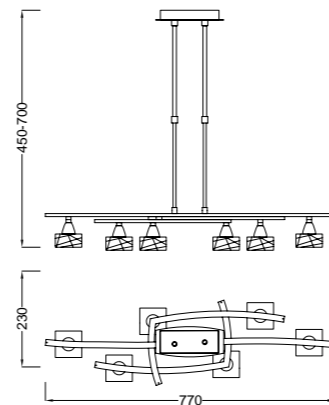

REF.1422/1432 Semi Plafón - Semi Ceiling Lamp



1422

- G9 LED 8x2,5W - 220/240V (incl.)
- Cristal Óptico - Optical Glass
- Cromo - Chrome

1432

- G9 LED 8x2,5W - 220/240V (incl.)
- Cristal Óptico - Optical Glass
- Cuero - Antique Brass

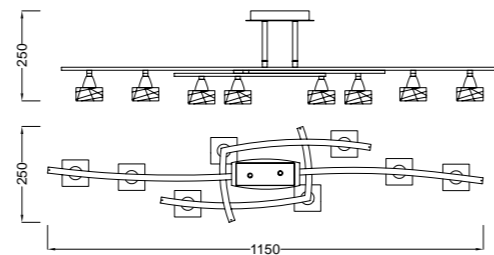

REF.1421/1431 Semi Plafón - Semi Ceiling Lamp



1421

- G9 LED 6x2,5W - 220/240V (incl.)
- Cristal Óptico - Optical Glass
- Cromo - Chrome

1431

- G9 LED 6x2,5W - 220/240V (incl.)
- Cristal Óptico - Optical Glass
- Cuero - Antique Brass

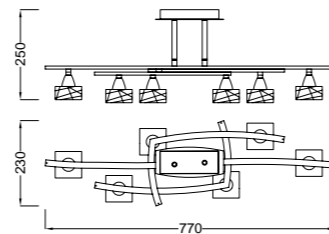

REF.1420/1430 Semi Plafón - Semi Ceiling Lamp



1420

- G9 LED 4x2,5W - 220/240V (incl.)
- Cristal - Glass
- Cromo - Chrome

1430

- G9 LED 4x2,5W - 220/240V (incl.)
- Cristal - Glass
- Cuero - Antique Brass

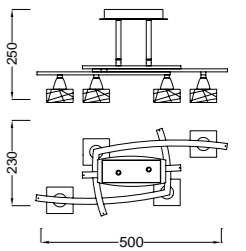

REF.1426/1436 Aplique - Wall Lamp



1426

- G9 LED 1x2,5W - 220/240V (incl.)
- Cristal - Glass
- Cromo - Chrome

1436

- G9 LED 1x2,5W - 220/240V (incl.)
- Cristal - Glass
- Cuero - Antique Brass



REF.1425/1435 Aplique - Wall Lamp



1425

- G9 LED 2x2,5W - 220/240V (incl.)
- Cristal - Glass
- Cromo - Chrome

1435

- G9 LED 2x2,5W - 220/240V (incl.)
- Cristal - Glass
- Cuero - Antique Brass

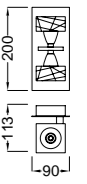

REF.1427/1437 Sobremesa - Table Lamp



1427

- G9 LED 1x2,5W - 220/240V (incl.)
- Cristal - Glass
- Cromo - Chrome

1437

- G9 LED 1x2,5W - 220/240V (incl.)
- Cristal - Glass
- Cuero - Antique Brass



# CUADRAX







## REF.0956/0004046/0996 Lámpara - Chandelier



0956

0996

G9 LED 8x2,5W - 220/240V (incl.)

Cristal - Glass

Cromo - Chrome

0004046

G9 LED 8x2,5W - 220/240V (incl.)

Cristal Óptico - Optical Glass

Níquel Satinado - Satin Nickel

G9 LED 8x2,5W - 220/240V (incl.)

Cristal - Glass

Cuero - Antique Brass

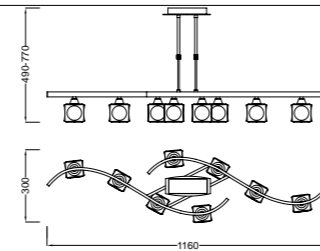

## REF.0951/0004024/0991 Semi Plafón - Semi Ceiling Lamp



0951

0991

G9 LED 8x2,5W - 220/240V (incl.)

Cristal - Glass

Cromo - Chrome

0004024

G9 LED 8x2,5W - 220/240V (incl.)

Cristal Óptico - Optical Glass

Níquel Satinado - Satin Nickel

G9 LED 8x2,5W - 220/240V (incl.)

Cristal - Glass

Cuero - Antique Brass

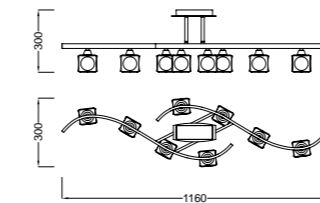

## REF.0955/0004045/0995 Lámpara - Chandelier



0955

0995

G9 LED 6x2,5W - 220/240V (incl.)

Cristal - Glass

Cromo - Chrome

0004045

G9 LED 6x2,5W - 220/240V (incl.)

Cristal Óptico - Optical Glass

Níquel Satinado - Satin Nickel

G9 LED 6x2,5W - 220/240V (incl.)

Cristal - Glass

Cuero - Antique Brass

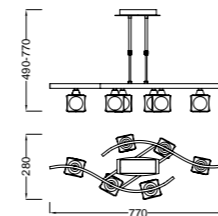

## REF.0950/0004023/0990 Semi Plafón - Semi Ceiling Lamp



0950

0990

G9 LED 6x2,5W - 220/240V (incl.)

Cristal - Glass

Cromo - Chrome

0004023

G9 LED 6x2,5W - 220/240V (incl.)

Cristal Óptico - Optical Glass

Níquel Satinado - Satin Nickel

G9 LED 6x2,5W - 220/240V (incl.)

Cristal - Glass

Cuero - Antique Brass

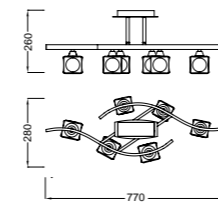

## REF.0957/0004049/0997 Plafón - Ceiling Lamp



0957

0997

G9 LED 4x2,5W - 220/240V (incl.)

Cristal - Glass

Cromo - Chrome

0004049

G9 LED 4x2,5W - 220/240V (incl.)

Cristal Óptico - Optical Glass

Níquel Satinado - Satin Nickel

G9 LED 4x2,5W - 220/240V (incl.)

Cristal - Glass

Cuero - Antique Brass

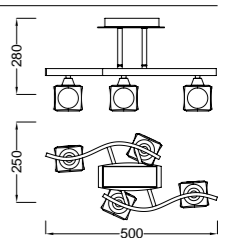

## REF.0952/0004029/0992 Aplique - Wall Lamp



0952

0992

G9 LED 1x2,5W - 220/240V (incl.)

Cristal - Glass

Cromo - Chrome

0004029

G9 LED 1x2,5W - 220/240V (incl.)

Cristal Óptico - Optical Glass

Níquel Satinado - Satin Nickel

G9 LED 1x2,5W - 220/240V (incl.)

Cristal - Glass

Cuero - Antique Brass

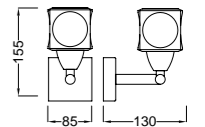

## REF.0953/0004030/0993 Aplique - Wall Lamp



0953

0993

G9 LED 2x2,5W - 220/240V (incl.)

Cristal - Glass

Cromo - Chrome

0004030

G9 LED 2x2,5W - 220/240V (incl.)

Cristal Óptico - Optical Glass

Níquel Satinado - Satin Nickel

G9 LED 2x2,5W - 220/240V (incl.)

Cristal - Glass

Cuero - Antique Brass

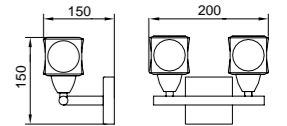

## REF.0954/0004031/0994 Sobremesa - Table Lamp



0954

0994

G9 LED 1x2,5W - 220/240V (incl.)

Cristal - Glass

Cromo - Chrome

0004031

G9 LED 1x2,5W - 220/240V (incl.)

Cristal Óptico - Optical Glass

Níquel Satinado - Satin Nickel

G9 LED 1x2,5W - 220/240V (incl.)

Cristal - Glass

Cuero - Antique Brass

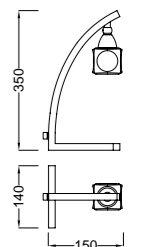

REF\_1111



REF\_0960



REF\_0966



REF\_1102



REF\_1105



REF\_1114



REF\_1117



REF\_0963



## REF.0966/1116/1106 Lámpara - Chandelier



0966

G9 LED 9x2,5W - 220/240V (incl.)

Cristal - Glass

Cromo - Chrome

1116

G9 LED 9x2,5W - 220/240V (incl.)

Cristal Óptico - Optical Glass

Níquel Satinado - Satin Nickel

1106

G9 LED 9x2,5W - 220/240V (incl.)

Cristal - Glass

Cuero - Antique Brass

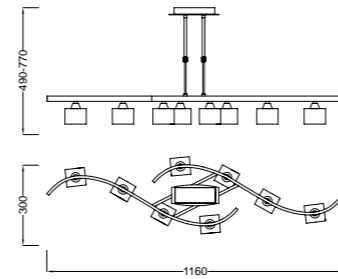

## REF.0961/1111/1101 Semi Plafón - Semi Ceiling Lamp



0961

G9 LED 8x2,5W - 220/240V (incl.)

Cristal - Glass

Cromo - Chrome

1111

G9 LED 8x2,5W - 220/240V (incl.)

Cristal Óptico - Optical Glass

Níquel Satinado - Satin Nickel

1101

G9 LED 8x2,5W - 220/240V (incl.)

Cristal - Glass

Cuero - Antique Brass

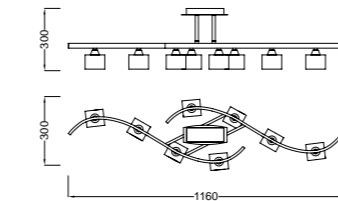

## REF.0965/1115/1105 Lámpara - Chandelier



0965

G9 LED 6x2,5W - 220/240V (incl.)

Cristal - Glass

Cromo - Chrome

1115

G9 LED 6x2,5W - 220/240V (incl.)

Cristal Óptico - Optical Glass

Níquel Satinado - Satin Nickel

1105

G9 LED 6x2,5W - 220/240V (incl.)

Cristal - Glass

Cuero - Antique Brass

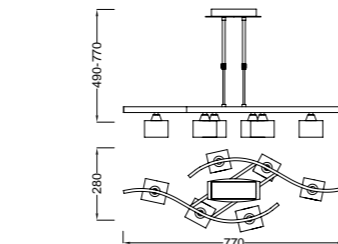

## REF.0960/1110/1100 Semi Plafón - Semi Ceiling Lamp



0960

G9 LED 6x2,5W - 220/240V (incl.)

Cristal - Glass

Cromo - Chrome

1110

G9 LED 6x2,5W - 220/240V (incl.)

Cristal Óptico - Optical Glass

Níquel Satinado - Satin Nickel

1100

G9 LED 6x2,5W - 220/240V (incl.)

Cristal - Glass

Cuero - Antique Brass

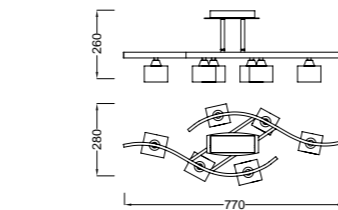

## REF.0967/1117/1107 Plafón - Ceiling Lamp



0967

G9 LED 4x2,5W - 220/240V (incl.)

Cristal - Glass

Cromo - Chrome

1117

G9 LED 4x2,5W - 220/240V (incl.)

Cristal Óptico - Optical Glass

Níquel Satinado - Satin Nickel

1107

G9 LED 4x2,5W - 220/240V (incl.)

Cristal - Glass

Cuero - Antique Brass

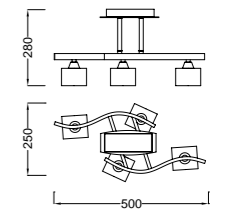

## REF.0962/1112/1102 Aplique - Wall Lamp



0962

G9 LED 1x2,5W - 220/240V (incl.)

Cristal - Glass

Cromo - Chrome

1112

G9 LED 1x2,5W - 220/240V (incl.)

Cristal Óptico - Optical Glass

Níquel Satinado - Satin Nickel

1102

G9 LED 1x2,5W - 220/240V (incl.)

Cristal - Glass

Cuero - Antique Brass

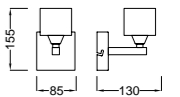

## REF.0963/1113/1103 Aplique - Wall Lamp



0963

G9 LED 2x2,5W - 220/240V (incl.)

Cristal - Glass

Cromo - Chrome

1113

G9 LED 2x2,5W - 220/240V (incl.)

Cristal Óptico - Optical Glass

Níquel Satinado - Satin Nickel

1103

G9 LED 2x2,5W - 220/240V (incl.)

Cristal - Glass

Cuero - Antique Brass

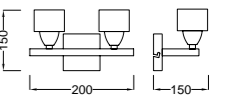

## REF.0964/1114/1104 Sobremesa - Table Lamp



0964

G9 LED 1x2,5W - 220/240V (incl.)

Cristal - Glass

Cromo - Chrome

1114

G9 LED 1x2,5W - 220/240V (incl.)

Cristal Óptico - Optical Glass

Níquel Satinado - Satin Nickel

1104

G9 LED 1x2,5W - 220/240V (incl.)

Cristal - Glass

Cuero - Antique Brass

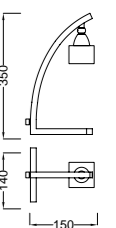

# INDEX

CODE	COLLECTION	PAGE	CODE	COLLECTION	PAGE	CODE	COLLECTION	PAGE
0004023	CUADRAX	222	1116	CUADRAX	226	3678	ZERO	80
0004024	CUADRAX	222	1117	CUADRAX	227	3679	DIAMANTE	70
0004029	CUADRAX	223	1420	ZEN	217	3691	ZERO	80
0004030	CUADRAX	223	1421	ZEN	216	3692	REEF	64
0004031	CUADRAX	223	1422	ZEN	216	3693	SPEAKER	68
0004045	CUADRAX	222	1423	ZEN	216	3694	MALDIVAS	63
0004046	CUADRAX	222	1424	ZEN	216	3921	02	196
0004049	CUADRAX	223	1425	ZEN	217	3922	02	196
0950	CUADRAX	222	1426	ZEN	217	3923	02	196
0951	CUADRAX	222	1427	ZEN	217	3926	02	197
0952	CUADRAX	223	1430	ZEN	217	3927	02	197
0953	CUADRAX	223	1431	ZEN	216	3928	02	197
0954	CUADRAX	223	1432	ZEN	216	3940	MAREMAGNUM	202
0955	CUADRAX	222	1433	ZEN	216	3941	MAREMAGNUM	202
0956	CUADRAX	222	1434	ZEN	216	3942	MAREMAGNUM	202
0957	CUADRAX	223	1435	ZEN	217	3943	MAREMAGNUM	203
0960	CUADRAX	226	1436	ZEN	217	3944	MAREMAGNUM	203
0961	CUADRAX	226	1437	ZEN	217	3945	MAREMAGNUM	203
0962	CUADRAX	227	1800	LOOP	209	3947	MAREMAGNUM	203
0963	CUADRAX	227	1801	LOOP	209	3948	MAREMAGNUM	203
0964	CUADRAX	227	1802	LOOP	209	3949	MAREMAGNUM	203
0965	CUADRAX	226	1803	LOOP	210	4070	MAREMAGNUM	202
0966	CUADRAX	226	1804	LOOP	210	4071	MAREMAGNUM	202
0967	CUADRAX	227	1805	LOOP	210	4072	MAREMAGNUM	202
0990	CUADRAX	222	1806	LOOP	211	4073	MAREMAGNUM	203
0991	CUADRAX	222	1807	LOOP	211	4074	MAREMAGNUM	203
0992	CUADRAX	223	1810	LOOP	209	4075	MAREMAGNUM	203
0993	CUADRAX	223	1811	LOOP	209	4077	MAREMAGNUM	203
0994	CUADRAX	223	1812	LOOP	209	4078	MAREMAGNUM	203
0995	CUADRAX	222	1813	LOOP	210	4079	MAREMAGNUM	203
0996	CUADRAX	222	1814	LOOP	210	4570	CRYSTAL LED	161
0997	CUADRAX	223	1815	LOOP	210	4571	CRYSTAL LED	161
1100	CUADRAX	226	1816	LOOP	211	4572	CRYSTAL LED	161
1101	CUADRAX	226	1817	LOOP	211	4573	CRYSTAL LED	162
1102	CUADRAX	227	1820	LOOP	209	4574	CRYSTAL LED	162
1103	CUADRAX	227	1821	LOOP	209	4575	CRYSTAL LED	162
1104	CUADRAX	227	1822	LOOP	209	4576	CRYSTAL LED	162
1105	CUADRAX	226	1823	LOOP	210	4577	CRYSTAL LED	163
1106	CUADRAX	226	1824	LOOP	210	4578	CRYSTAL LED	163
1107	CUADRAX	227	1825	LOOP	210	4579	CRYSTAL LED	163
1110	CUADRAX	226	1826	LOOP	211	4580	CRYSTAL LED MIRROR	169
1111	CUADRAX	226	1827	LOOP	211	4581	CRYSTAL LED MIRROR	169
1112	CUADRAX	227	2331	CRYSTAL G9	183	4582	CRYSTAL LED MIRROR	169
1113	CUADRAX	227	2332	CRYSTAL G9	183	4583	CRYSTAL LED	160
1114	CUADRAX	227	3673	ZERO	62/80	4584	CRYSTAL LED	160
1115	CUADRAX	226	3677	ZERO	80	4585	CRYSTAL LED	160

# INDEX

CODE	COLLECTION	PAGE	CODE	COLLECTION	PAGE	CODE	COLLECTION	PAGE
4586	CRYSTAL LED	160	5342	REFLEX	97	5674	READING	109
4587	CRYSTAL LED	161	5344	REFLEX	97	5710	BOLA	119
4600	CRYSTAL BALLS	173	5410	ZERO	81	5711	BOLA	119
4601	CRYSTAL BALLS	173	5411	ZERO	81	5712	BOLA	119
4602	CRYSTAL BALLS	173	5490	PETACA	55	5713	BOLA	119
4603	CRYSTAL BALLS	175	5491	PETACA	55	5735	BURBUJA	123
4604	CRYSTAL BALLS	175	5511	PETACA	55	5750	AROS	16
4605	CRYSTAL BALLS	175	5512	PETACA	55	5751	AROS	16
4607	CRYSTAL BALLS	177	5520	KAWAI	191	5752	AROS	17
4608	CRYSTAL BALLS	177	5521	KAWAI	191	5755	AROS	17
4609	CRYSTAL BALLS	177	5522	KAWAI	191	5756	AROS	17
4610	CRYSTAL BALLS	177	5523	KAWAI	191	5790	BURBUJA	123
4611	CRYSTAL G9	183	5530	TUBE	127	5792	BURBUJA	123
4612	CRYSTAL G9	183	5531	TUBE	127	5795	NISEKO	21
4613	CRYSTAL G9	183	5532	TUBE	127	5796	NISEKO	21
4614	CRYSTAL BRONCE	187	5533	TUBE	127	5797	NISEKO	21
4615	CRYSTAL BRONCE	187	5534	TUBE	127	5878	ONDAS MUSIC	69
4616	CRYSTAL BRONCE	187	5550	CORAL	145	5885	STRASS	131
4840E	ARGENTA	60	5551	CORAL	145	5920	MALE	85
4841E	ARGENTA	60	5552	CORAL	145	5921	MALE	85
4842E	ARGENTA	60	5553	CORAL	145	5922	MALE	85
4843E	ARGENTA	60	5560	VERSAILLES	26	5923	MALE	85
4846E	ARGENTA	61	5561	VERSAILLES	26	5925	ARI	93
4847E	ARGENTA	61	5562	VERSAILLES	27	5926	ARI	93
4848E	ARGENTA	61	5563	VERSAILLES	27	5927	ARI	93
4849E	ARGENTA	61	5564	VERSAILLES	27	5929	VIRGIN SAND	66
4970	VINTAGE	138	5580	ZURICH	33	5930	CENTARA	89
4971	VINTAGE	138	5581	ZURICH	33	5931	CENTARA	89
4972	VINTAGE	138	5582	ZURICH	33	5933	REEF	65
4973	VINTAGE	139	5590	CUBE	49	5935	DIAMANTE II	75
4974	VINTAGE	139	5591	CUBE	49	5936	DIAMANTE II	75
4975	VINTAGE	139	5592	CUBE	49	5938	DIAMANTE	71
5090	CRYSTAL LED MIRROR	169	5593	CUBE	49	5940	ZERO II	79
5091	CRYSTAL LED MIRROR	169	5600	SWISS	45	5941	ZERO II	79
5092	CRYSTAL LED MIRROR	169	5601	SWISS	45	5942	ZERO II	79
5093	WINDOWS	149	5602	SWISS	45	5943	ZERO II	79
5094	WINDOWS	149	5650	NATALIA	114	5944	ZERO II	79
5100	SURF	40	5651	NATALIA	114	5945	ZERO II	79
5101	SURF	40	5652	NATALIA	115	5970	DIAMANTE II	75
5102	SURF	40	5655	NATALIA	114	5971	DIAMANTE II	75
5103	SURF	40	5656	NATALIA	115	6040	LADY	101
5104	SURF	41	5657	NATALIA	115			
5110	VIRGIN	67	5670	READING	108			
5115	SATURNO	153	5671	READING	108			
5340	REFLEX	97	5672	READING	108			
5341	REFLEX	97	5673	READING	109			

# TECHNICAL DATA

Ahorrar energía no es solo ayudar a mejorar y proteger el medio ambiente, también ahorrando energía ayudamos a mejorar nuestra economía domestica, ventajas que alcanzan a nuestro bolsillo y que se traducen por sí mismas en una mejor calidad de vida. Así pues, MANTRA, es consciente de aportar producto al mercado de la iluminación con este fin, el de mejorar la eficiencia energética, da un paso más al pretender que sus elementos de iluminación aporten también diseño. Sabedores que hoy por hoy todos los elementos LED existentes en el mercado, si cada vez son más eficientes y potentes, son ante todo antiestéticos en cualquier ubicación en el hogar. Por eso hemos proyectado una línea de trabajo, posiblemente innovadora en todos los mercados, con la meta de “vestir el LED”.

Todos nuestros productos han superado un riguroso control de calidad a lo largo de todo el proceso de fabricación, desde la elección de los materiales hasta el embalaje final. Cumplen todas las normativas vigentes relativas a la seguridad y al respeto del medio ambiente. Colaboramos con laboratorios independientes para controlar y certificar nuestra calidad.

Nuestros productos cumplen las normas de seguridad y electromagnetismo de Europa: EN 60598 y marcado CE.

Así mismo, todos y cada uno de nuestros productos son piezas originales y de diseño propiedad de Global Manufacturing anfTrading Company S.L estando todas ellas seriadas y protegidas como tales en el registro de patentes y marcas OAMI ( para su mayor información visita la página <https://oami.europa.eu/eSearch/#advanced/designs>

Saving energy not only helps to improve and protect the environment but saving energy is also essential to improve our household economy, advantages which benefit our finances and help to improve the quality of our lifestyle. Hence aware of the importance of supplying such products to the lighting market with this aim, MANTRA also takes one step further to create an attractive design for its lighting elements. As everyone knows all the LED lighting elements available in today's market are increasingly efficient and powerful however they have a very anti-aesthetic image when installed inside the home. Accordingly, we have designed a new product line, possibly the most innovative in all markets with the goal of “dress the LED”.

All our products have passed strict quality control checks throughout the production process. From the choice of materials to the final package. They also comply with all the applicable regulations concerning safety and respect to the enviroment. We collaborate with independent laboratories in order to control and certify our quality.

Our products are conformity with the set safety and electromagnetism appropriate standars of Europe: EN 60598 and CE marked.

All of our products are original pieces and the property of Global Manufacturing and Trading Company S.L all products are registered designs and protected internationally by registration of design. Intellectual proprierty rights. Copyright protection and patents. For further information <https://oami.europa.eu/eSearch/#advanced/designs>

# SYMBOLS

## Normativa - Normative

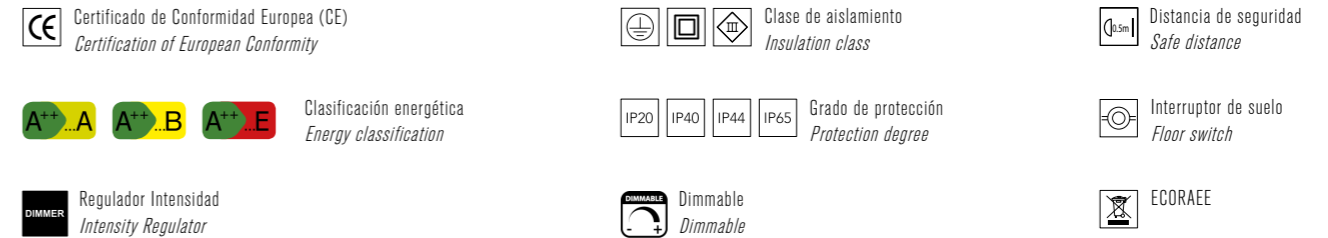

## Fuentes de Luz - Lighting Sources



## Acabados - Finishes

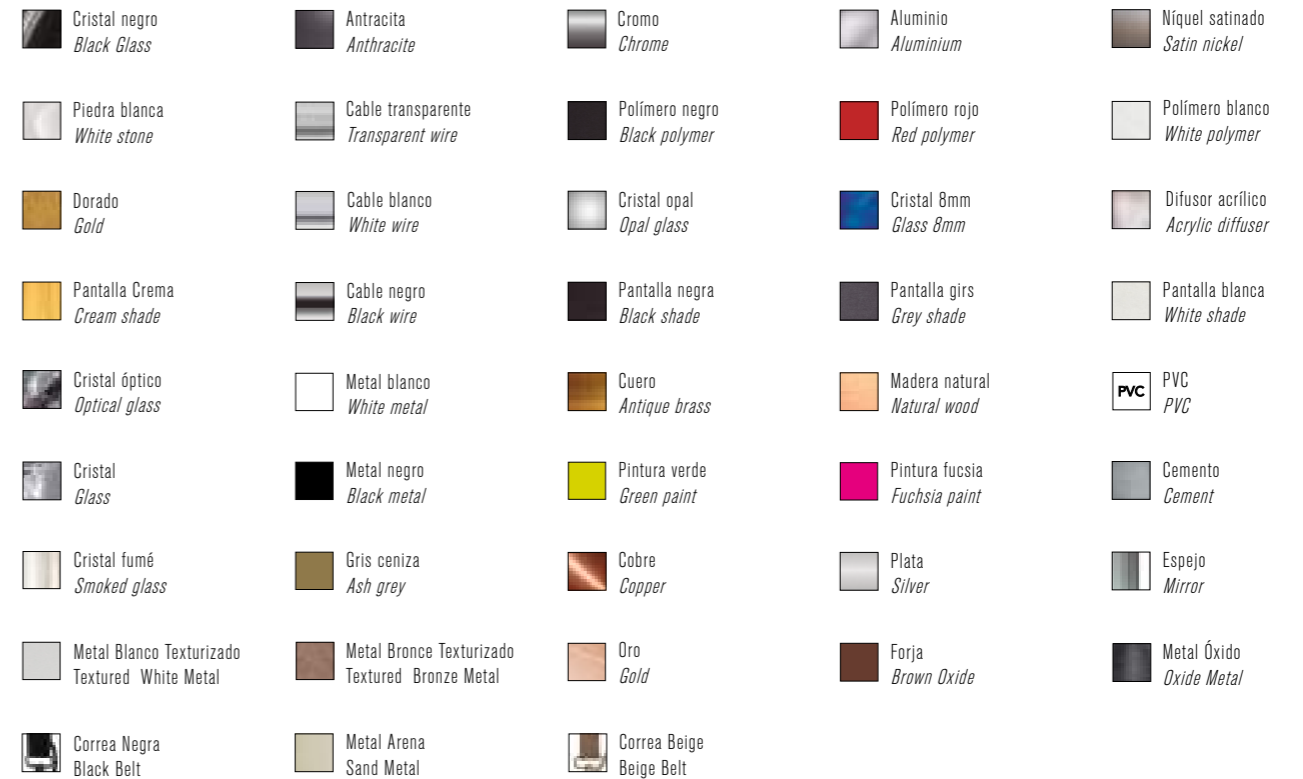

## Importante/Important

Modelos a 230v 50Hz, conformidad CE. No utilizar bombillas de potencia superior a la indicada.  
 230v 50Hz models, CE approval. Do not use lamps with higher power than indicated.

## CREDITS

### STYLISTS:

Hugo Tejada

### PHOTOGRAPHY

Estudio Aviño  
Jose de Les Woltes  
Angel Belmar

### THANKS TO

Ivan Manzaneda  
Susana Valles  
Jose I. Ballester  
Kike Sebastian  
Javier Calvo

### FONTYPE

Helvetica  
Sansita  
Akzidenz-Grotesk

### PAPER

Creator Star de 300 gr.  
Creator Star de 150 gr.

### MADE AND PRINTED

Spain

### Global Manufacturing and Trading Company S.L

Polígono Industrial los Vientos  
Calle Aliso, parcela nº4  
46119, Náquera, Valencia, SPAIN  
T +34 96 160 99 50  
F +34 96 160 99 48  
mantra@mantraco.org  
www.mantrailuminación.com

